

Edited by  
Volodymyr Sadkovyi,  
Evgeniy Rybka,  
Yurii Otrosh

# FIRE RESISTANCE OF REINFORCED CONCRETE AND STEEL STRUCTURES

Monograph



2021

**UDC 614.8**  
**F56**

Published in 2021  
by PC TECHNOLOGY CENTER  
Shatylova dacha str., 4, Kharkiv, Ukraine, 61165

Approved by the Academic Council of National University of Civil Defence of Ukraine,  
Protocol No. 2 of 28.10.2021

**Reviewers:**

**Maksym Kustov**, Doctor of Technical Sciences, Associate Professor, Head of Department, Scientific Department of Civil Protection and Technogenic and Environmental Security, National University of Civil Defence of Ukraine;

**Viktor Sopov**, Doctor of Technical Sciences, Professor, Acting Head of Department, Department of Building Materials and Technologies, Kharkiv National University of Civil Engineering and Architecture.

**F56**

**Authors:**

Edited by Volodymyr Sadkovyi, Evgeniy Rybka, Yuri Otrosh  
Volodymyr Sadkovyi, Volodymyr Andronov, Oleg Semkiv, Andrii Kovalov, Evgeniy Rybka, Yuri Otrosh, Mykola Udianskyi, Volodymyr Koloskov, Alexander Danilin, Pavlo Kovalov  
Fire resistance of reinforced concrete and steel structures: monograph / V. Sadkovyi, E. Rybka, Yu. Otrosh and others. – Kharkiv: PC TECHNOLOGY CENTER, 2021. – 180 p.

The monograph will be of interesting to applicants for higher education, scientists and practitioners in the field of "Civil Security" in the specialty "Fire Safety". The interest of the presented scientific results is that for the first time the problem of ensuring fire resistance of reinforced concrete and steel building structures is comprehensively solved in the work. The proposed computational and experimental methods, which are universal and based on multifactor models, allowed to achieve this. The monograph will be interesting for all regions of the world.

Designed for professionals and scientists engaged in scientific and practical activities in the field of fire safety, as well as scientific, scientific and academic staff and applicants for higher education in the field of "Fire Safety", as well as professionals who at the scientific and practical level ensuring fire safety of civil and industrial facilities.

Figures 82, Tables 8, References 246 items.

All rights reserved. No part of this book may be reprinted or reproduced or utilised in any form or by any electronic, mechanical, or other means, now known or hereafter invented, including photocopying and recording, or in any information storage or retrieval system, without permission in writing from the authors. This book contains information obtained from authentic and highly regarded sources. Reasonable efforts have been made to publish reliable data and information, but the author and publisher cannot assume responsibility for the validity of all materials or the consequences of their use. The authors and publishers have attempted to trace the copyright holders of all material reproduced in this publication and apologize to copyright holders if permission to publish in this form has not been obtained. If any copyright material has not been acknowledged please write and let us know so we may rectify in any future reprint.

The publisher, the authors and the editors are safe to assume that the advice and information in this book are believed to be true and accurate at the date of publication. Neither the publisher nor the authors or the editors give a warranty, express or implied, with respect to the material contained herein or for any errors or omissions that may have been made.

Trademark Notice: Product or corporate names may be trademarks or registered trademarks, and are used only for identification and explanation without intent to infringe.

**DOI: 10.15587/978-617-7319-43-5**  
**ISBN 978-617-7319-43-5 (online)**  
**ISBN 978-617-7319-42-8 (print)**



Copyright © 2021 V. Sadkovyi, E. Rybka, Yu. Otrosh and others authors  
This is an open access paper under the Creative Commons CC BY license

## AUTHORS

### **VOLODYMYR SADKOVYI**

Doctor of Science in Public Administration, Professor,  
Rector

National University of Civil Defence of Ukraine

 ORCID ID: <https://orcid.org/0000-0001-7054-671X>

### **VOLODYMYR ANDRONOV**

Doctor of Technical Sciences, Professor,  
Vice Rector on Scientific Work  
Research Center

National University of Civil Defence of Ukraine

 ORCID ID: <https://orcid.org/0000-0001-7486-482X>

### **OLEG SEMKIV**

Doctor of Technical Sciences, Professor,  
Vice Rector

National University of Civil Defence of Ukraine

 ORCID ID: <https://orcid.org/0000-0002-9347-0997>

### **ANDRII KOVALOV**

PhD, Senior Researcher

National University of Civil Defence of Ukraine

 ORCID ID: <https://orcid.org/0000-0002-6525-7558>

### **EVGENIY RYBKA**

Doctor of Technical Sciences, Senior Researcher  
Research Center

National University of Civil Defence of Ukraine

 ORCID ID: <https://orcid.org/0000-0002-5396-5151>

### **YURIY OTROSH**

Doctor of Technical Sciences, Professor

Department of Fire Prevention in Settlements

National University of Civil Defence of Ukraine

 ORCID ID: <https://0000-0003-0698-2888>

### **MYKOLA UDIANSKYI**

PhD, Associate Professor

Faculty of Civil Defence

National University of Civil Defence of Ukraine

 ORCID ID: <https://orcid.org/0000-0001-5107-936X>

### **VOLODYMYR KOLOSKOV**

PhD, Associate Professor

Department of Applied Mechanics and Environmental  
Protection Technologies

National University of Civil Defence of Ukraine

 ORCID ID: <https://orcid.org/0000-0002-9844-1845>

### **ALEXANDER DANILIN**

PhD, Assistant Professor

Department of Supervisory and Preventive Activities

National University of Civil Defence of Ukraine

 ORCID ID: <https://0000-0002-4474-7179>

### **PAVLO KOVALOV**

PhD, Associate Professor

Department of Fire and Rescue Training

National University of Civil Defence of Ukraine

 ORCID ID: <https://0000-0002-2817-5393>

## ABSTRACT

The scientific bases of ensuring fire resistance of reinforced concrete and steel building structures in the conditions of modern extreme influences are laid.

The current state of fire safety of buildings and structures, as well as approaches, methods and tools for its assessment are analyzed. Analysis of emergencies and fires in the world has shown that the vast majority of them occur in buildings and structures. It is shown that the cause of catastrophic consequences and destruction is the non-compliance of the actual limit of fire resistance of building structures with regulatory requirements. This is due to the imperfection of methods and means of assessing the fire resistance of building structures, including fire-retardant.

To overcome the shortcomings identified during the analysis, the paper develops physical and mathematical models of thermal processes occurring in the fire-retardant reinforced concrete structure. Based on the proposed models, a computational-experimental method for estimating the fire resistance of such structures has been developed. The efficiency of the proposed method was tested by identifying the relationship between the parameters of the fire-retardant plaster coating "Neospray" and the fire resistance of fire-retardant multi-hollow reinforced concrete floor.

The study of fire resistance of steel structures is proposed to be carried out using reduced samples in the form of steel plates with dimensions of  $500 \times 500 \times 5$  mm. Based on the proposed models, a calculation and experimental method for estimating the fire resistance of steel structures, as well as an algorithm and procedures for its implementation have been developed. The verification of the efficiency of the proposed method was carried out in the ANSYS software package using the aged coating "Phoenix STS" and the coating "Amotherm Steel Wb" under heating conditions at the temperature of the hydrocarbon fire.

The reliability of the developed models and methods is checked. It is established that random errors in temperature measurement significantly affect the accuracy of determining the thermo-physical characteristics and limits of fire resistance. In general, the efficiency of the proposed calculation and experimental methods with sufficient accuracy for engineering calculations is confirmed.

### KEYWORDS

Fire resistance, fire resistance assessment method, fire protection, fire protective coatings, fireproof building structures, fire protection ability of coatings, fire temperature regimes, thermo-physical characteristics.

# CONTENTS

<b>List of Tables</b> .....	vii
<b>List of Figures</b> .....	viii
<b>Circle of readers and scope of application</b> .....	xiv
<b>Introduction</b> .....	1
<b>1 Current state of ensuring fire resistance of reinforced concrete and steel building structures</b> .....	4
1.1 Fire resistance of building structures as a condition for safe operation of buildings and structures .....	4
1.2 Fire safety requirements for building structures used in modern construction .....	8
1.3 Analysis of statistical data .....	15
1.3.1 Fire statistics .....	15
1.3.2 Analysis of emergencies and fires associated with loss of fire resistance .....	15
1.4 Modern approaches to fire resistance .....	22
1.4.1 Fire protection of reinforced concrete structures .....	23
1.4.2 Fire-retardant materials used for fire protection of steel structures .....	26
Conclusions on Section 1 .....	31
<b>2 Analysis of the state of the issue regarding the assessment of fire resistance of reinforced concrete and steel building structures</b> .....	33
2.1 Methods for assessing the fire resistance of building structures .....	33
2.1.1 Experimental methods .....	33
2.1.2 Calculation methods .....	35
2.1.3 Calculation and experimental methods .....	39
2.2 Test equipment for the study of fire resistance of reinforced concrete and steel building structures .....	41
2.3 Analysis of the conditions for conducting research on reinforced concrete and steel building structures for fire resistance .....	44
2.3.1 Estimated temperature scenarios for the study of reinforced concrete and steel building structures for fire resistance .....	45
2.3.2 Influence of climatic factors on fire-retardant ability of coverings of fire-resistant building constructions .....	50
2.4 System analysis of the process of ensuring fire resistance of building structures .....	57
Conclusions on Section 2 .....	60

<b>3 Calculation and experimental method of evaluation of fire resistance of fire protected reinforced concrete structures</b> .....	62
3.1 Development of physical and mathematical models of fire resistance of fire-retardant reinforced concrete structure .....	62
3.1.1 Algorithm for developing a mathematical model.....	63
3.1.2 Initial and boundary conditions in the construction of the model for the thermal task .....	64
3.2 Development of a structural-logical scheme of the computational-experimental method.....	68
3.2.1 Choosing a method for solving inverse thermal conductivity problems .....	71
3.3 Checking the efficiency of the proposed calculation and experimental method .....	77
Conclusions on the Section 3 .....	83
<b>4 Calculation and experimental method of evaluation of fire resistance of fire protected steel structures</b> .....	85
4.1 Mathematical model for estimating the fire resistance of a fire-resistant steel structure.....	85
4.2 Development of a structural-logical scheme of the computational-experimental method.....	90
4.3 The procedure for implementing the calculation and experimental method .....	92
4.3.1 Determination of the influence of climatic factors and temperature of the fire ..	92
4.3.2 Determination of the influence of temperature regimes of fire (on the example of the temperature regime of hydrocarbon fire) .....	99
Conclusions on Section 4.....	108
<b>5 Verification of developed mathematical models and calculation-experimental methods</b> .	111
5.1 Verification of the reliability of the developed mathematical model and method for assessing the fire resistance of fire-retardant reinforced concrete structures....	111
5.2 Verification of the reliability of the developed mathematical model and calculation-experimental method for estimating the fire resistance of fire-retardant steel structures .....	121
5.3 Development of an installation for determining the adhesive strength of coatings of fire-retardant steel structures .....	136
5.4 Verification of the reliability of the installation to determine the adhesive strength of coatings of fire-retardant steel structures.....	139
Conclusions on the Section 5 .....	140
<b>Conclusions</b> .....	142
<b>References</b> .....	145

## LIST OF TABLES

2.1	Cycles of simulation of aging of fire-retardant coatings	51
2.2	Climatic conditions during accelerated tests that simulate operation in a dry heated room	54
2.3	Climatic conditions during accelerated tests that simulate operation under a canopy in a non-heated room	55
3.1	Means of measuring equipment	78
5.1	Sensitivity of temperatures at the measuring points to the parameters of the model of thermal conductivity of fire-retardant plaster-coated reinforced concrete structure (on the example of multi-hollow reinforced concrete floor)	112
5.2	Values of the minimum thickness of the investigated plaster coating to ensure the normalized limit of fire resistance of the floor 180 minutes	119
5.3	Geometric dimensions of the steel column NEV 200 for modelling its non-stationary heating in the software environment ANSYS R17.1	124
5.4	Test results of coatings for adhesive strength	139

## LIST OF FIGURES

1.1	Limit states of fire resistance of building structures	5
1.2	General view of the steel beam	12
1.3	General view of the steel truss	13
1.4	General view of metal columns	13
1.5	Fire at the Saratov Oil Refinery on October 4, 2012	16
1.6	Fire in the reservoir park of the "Usa" oil treatment plant (Komi Republic, May 21, 2014)	17
1.7	Destruction of structures because of the accident at the Achinsk refinery in June 2014	17
1.8	Progressive collapse of metal structures of the building because of fire	18
1.9	Collapse of a 5-storey supermarket in Seoul, 1995	19
1.10	Collapse of the St. Petersburg sports complex, January 31, 2020	19
1.11	The collapse of a three-story building in Bhiwandi, India, on September 21, 2020	20
1.12	Collapse of a nine-storey residential building in the city of Astrakhan, February 27, 2012	20
1.13	The scheme of deformation of floor slabs: <i>a</i> – as elements of the hanging system; <i>b</i> – the inner walls of a large-panel building	21
2.1	General scheme of the calculation-experimental method	39
2.2	Scheme of the vertical test furnace: 1 – furnace body; 2 – burners; 3 – channel for exhaust gases; 4 – sample being tested; 5 – thermocouples in the furnace; 6 – exhaust hood	42
2.3	Scheme of the horizontal furnace: 1 – furnace body; 2 – burners; 3 – channels for exhaust gases; 4 – sample being tested; 5 – thermocouples in the furnace; 6 – load on the sample; 7 – hinged supports	42
2.4	General view of special test furnaces: <i>a</i> – LLC "Test"; <i>b</i> – LLC "Donstroytest"	43
2.5	Dependence of temperature change on the duration of fire exposure at different heating rates: 1 – standard temperature curve according to ISO 834 and GOST 30247.0-94; 2 – hydrocarbon curve according to EN 1363-2:1999; 3 – minimized a single standard temperature curve according to ISO 834; 4 – external fire curve according to EN 1363-2:1999; 5 – tunnel curve according to German standards (RABT); 6 – tunnel curve according to the standards of the Netherlands (RWS)	46
3.1	Structural and logical scheme of building a mathematical model	63
3.2	Scheme of reinforced concrete floor: <i>a</i> – one-dimensional setting; <i>b</i> – two-dimensional formulation; 1 – layer of solid concrete floor between the unheated surface and the layer with cavities; 2 – layer with cavities; 3 – layer of solid concrete between cavities	



LIST OF FIGURES

---

and reinforcement; 4 – reinforcement layer; 5 – a layer of solid concrete from the reinforcement to the heating surface; 6 – plaster coating; $h$ – the thickness of the plate; $b$ – width of the plate; $y$ – coordinate along the width of the structure; $x$ – the coordinate of the thickness of the structure	64
3.3 Multi-hollow reinforced concrete floor PC 48-12-8t: $a$ – general view; $b$ – scheme of the periodic part (fragment) of the coated plate used in 2D modelling: 1 – heating surface; 2 – fire-retardant coating; 3 – reinforced concrete floor; 4 – unheated surface; 5 – cavity (round cavity) floor	67
3.4 Scheme of calculation and experimental method	69
3.5 Scheme of calculation and experimental method and the procedure for its implementation	70
3.6 Dependence of the temperature in the furnace on the time of fire exposure on the heating surface of the fire-retardant reinforced concrete multi-hollow slab with a thickness of 220 mm: 1 – curve of standard temperature regime; 2 – real curve of temperature change in the furnace; 3 – the minimum values of temperature in the furnace are admissible at tests; 4 – the maximum values of temperature in the furnace are admissible at tests	78
3.7 Dependence of temperature on the time of fire exposure from the unheated surface of fire-retardant multi-hollow reinforced concrete floor in different places of temperature measurement	79
3.8 Dependence of the effective coefficient of thermal conductivity of concrete of fire-retardant reinforced concrete multi-hollow floor on temperature, obtained as a result of solving the inverse problems of thermal conductivity according to fire resistance tests	80
3.9 Dependence of the effective coefficient of thermal conductivity of plaster coating on the temperature found by solving the inverse problems of thermal conductivity according to the tests of fire resistance of fire-resistant multi-hollow reinforced concrete floor	80
3.10 Dependence of temperature on time of fire influence from unheated surface of fire-protected reinforced concrete floor: 1 – experimental temperature from unheated surface; 2 – design temperature obtained by solving the inverse problems of thermal conductivity	81
3.11 Dependence of the thickness ( $\delta$ ) of “Neospray” plaster coating on the thickness of the protective layer of concrete of multi-hollow reinforced concrete floor ( $a$ ) according to the criterion of reaching the critical temperature of reinforcement (500 °C) for fire resistance: 1 – 60 minutes; 2 – 90 minutes; 3 – 120 minutes; 4 – 150 minutes; 5 – 180 minutes; 6 – 240 minutes	82
4.1 Geometric diagram of a metal sample with a thickness of $d_a/2$ with a fire-retardant coating with a thickness of $d_p$	87

---

4.2	Physical model of the thermal state in the system “fire-retardant coating – steel plate – insulation”: 1 – fire-retardant coating; 2 – steel plate; 3 – 2 layers of heat-insulating material	90
4.3	Scheme of calculation and experimental method for assessing the fire resistance of fire-resistant steel structures and methods of its application	91
4.4	Structural and logical scheme of methods for studying the durability of fire-retardant coatings	92
4.5	Type of steel samples: <i>a</i> – before applying the flame retardant; <i>b</i> – after applying a flame retardant	93
4.6	Layout of thermocouples from the unheated surface of the steel plate before the test	94
4.7	View of the sample from the unheated surface of the steel plate	95
4.8	Dependence of temperature in the furnace on the duration of fire exposure: 1 – curve of standard temperature regime; 2 – real curve of temperature change in the furnace	95
4.9	Dependence of temperature on the unheated surface of the steel plate of sample №1 on the time of fire exposure at different points of temperature measurement: 1 – thermocouple installed at a distance of 100 mm from the upper edge of the plate; 2 – thermocouple mounted in the center of the plate; 3 – thermocouple installed at a distance of 100 mm from the lower edge of the plate; $T_{av}$ – the average value of the three thermocouples	96
4.10	Characteristic appearance of a swollen fire-retardant coating after fire exposure	97
4.11	Dependence of the effective thermal conductivity of the coating on temperature, found by solving the inverse problem of thermal conductivity	98
4.12	Testing according to the international standard ISO 22899-1:2007 and ISO/CD 22899-2:2009	100
4.13	General view of the airless spraying unit	102
4.14	Layout of thermocouples and thickness of the coating in the places of measurement: the first digit – the thickness of the fire-retardant coating with soil, mm; the second digit is the thickness of the swelling, mm; the third digit is the location of the thermocouple	103
4.15	Layout of thermocouples from the unheated surface of the steel plate	104
4.16	Dependence of temperature in the furnace on duration of fire influence: 1 – curve of a temperature mode of a hydrocarbon fire; 2 – temperature curve during the experiment in the furnace	104
4.17	Dependence of temperature from the unheated surface of the steel plate on the time of fire exposure at different points of temperature measurement: T1 – thermocouple installed at a distance of 100 mm from the upper edge of the plate; T2 – thermocouple installed in the center of the plate; T3 – thermocouple installed at a distance of 100 mm from the lower edge of the plate; $T_{av}$ – the average value of the three thermocouples	105
4.18	General view of “Amotherm Steel Wb” coated steel plate after testing	106

---

---

4.19	Dependence of temperature on an unheated surface of a steel plate on time of fire influence at various temperature modes of fire: 1 – standard fire; 2 – hydrocarbon fire	106
4.20	Dependence of the effective coefficient of thermal conductivity of the investigated fire-retardant coating on the temperature found by solving the inverse problems of thermal conductivity	107
4.21	Dependence of the minimum thickness of the investigated fire-retardant coating ( $\delta_p$ ) on the thickness of the steel plate ( $\delta$ ) for the critical steel temperature of 500 °C and the normalized duration of fire exposure of 30 minutes: 1 – at the temperature of hydrocarbon fire; 2 – at standard fire temperature	108
5.1	Fire-resistant multi-hollow reinforced concrete floor: <i>a</i> – general view before the test; <i>b</i> – layout of thermocouples	113
5.2	Accurate and perturbed up to 10 % of temperature values from the unheated surface of the fire-retardant reinforced concrete floor: 1 – exact curve; 2 – curve perturbed by 10 %	114
5.3	Dependence of the effective coefficient of thermal conductivity of the investigated plaster coating on temperature: 1 – exact coefficients; 2 – coefficients obtained by solving the inverse problems of thermal conductivity at perturbed temperatures by 10 %	115
5.4	Scheme of multi-hollow reinforced concrete floor in one-dimensional formulation: 1 – a layer of solid concrete between the unheated surface and the layer with floor cavities; 2 – layer with voids; 3 – a layer of solid concrete between the cavities and reinforcement; 4 – armature layer; 5 – a layer of solid concrete from the reinforcement to the heated surface; 6 – plaster coating	115
5.5	Dependence of the effective coefficient of thermal conductivity of the plaster coating on the temperature found by solving the inverse problems of thermal conductivity according to the data on fire resistance tests: 1 – at $\alpha_{c2}$ , which depends on the temperature; 2 – $\alpha_{c2}=3 \text{ W}/(\text{m}^2\cdot^\circ\text{C})$ ; 3 – $\alpha_{c2}=4 \text{ W}/(\text{m}^2\cdot^\circ\text{C})$ ; 4 – $\alpha_{c2}=5 \text{ W}/(\text{m}^2\cdot^\circ\text{C})$ ; 5 – $\alpha_{c2}=6 \text{ W}/(\text{m}^2\cdot^\circ\text{C})$ ; 6 – $\alpha_{c2}=7 \text{ W}/(\text{m}^2\cdot^\circ\text{C})$	116
5.6	Dependence of the effective coefficient of thermal conductivity of plaster coating on the temperature found by solving the inverse problems of thermal conductivity according to fire resistance tests	118
5.7	Dependence of temperature change on the duration of fire exposure in different fire modes, where: 1 – standard temperature curve according to ISO 834 and GOST 30247.0-94; 2 – hydrocarbon curve according to EN 1363-2:1999; 3 – tunnel curve according to Netherland's standards (RWS)	118
5.8	Characteristics of fire-retardant ability of the investigated plaster coating according to the criterion of reaching the critical temperature of reinforcement (500 °C) for the limit of fire resistance of 180 minutes: 1 – for standard temperature regime; 2 – for the hydrocarbon fire mode; 3 – for tunnel fire mode according to Dutch standards (RWS)	119

---

5.9	Temperature distribution in a multi-hollow floor slab during modelling in the ANSYS R17.1 software package	120
5.10	Dependence of temperature on the time of fire exposure from the unheated surface of a multi-hollow reinforced concrete floor in different places of temperature measurement: 1 – temperatures found during the fire resistance test; 2 – when modelling in the software package ANSYS R17.1	121
5.11	Dependence of temperature in the furnace on duration of fire influence: 1 – curve of standard temperature mode; 2 – real curve of temperature change in the furnace; 3 – the maximum values of temperature in the furnace are admissible at tests; 4 – the minimum values of temperature in the furnace are admissible at tests	122
5.12	Dependence of average temperatures of samples of steel columns with fire-retardant coating “Amotherm Steel Wb” on the time of fire exposure to the standard temperature of the fire: 1 – sample column № 1; 2 – sample column № 2	123
5.13	Dependence of the effective thermal conductivity of the coating “Amotherm Steel Wb” on the temperature found by solving the inverse problems of thermal conductivity	123
5.14	Steel column: <i>a</i> – general view; <i>b</i> – geometric dimensions	124
5.15	Physical model of fire-retardant steel column: 1 – steel structure; 2 – fire-retardant coating	125
5.16	Accurate and perturbed up to 10 % of temperature values from the unheated surface of the fire-retardant steel structure: 1 – exact curve; 2 – perturbed by 10 % curve	126
5.17	Accurate and perturbed up to 20 % of temperature values from the unheated surface of the fire-retardant steel structure: 1 – exact curve; 2 – perturbed by 20 % curve	126
5.18	Dependence of the effective coefficient of thermal conductivity of fire-retardant coating on temperature, where: 1 – exact coefficients; 2 – coefficients obtained by solving the inverse problems of thermal conductivity at perturbed temperatures by 10 %	127
5.19	Experimental and calculated values of temperatures from the unheated surface of the fire-retardant steel structure during their perturbation by 10 %: 1 – experimental curve; 2 – calculated curve	127
5.20	Dependence of effective coefficient of thermal conductivity of fire-retardant coating on temperature, where: 1 – exact coefficients; 2 – coefficients obtained by solving the inverse problems of thermal conductivity at perturbed temperatures by 20 %	128
5.21	Experimental and calculated values of temperatures from the unheated surface of the fire-retardant steel structure during perturbation by 20 %: 1 – exact curve; 2 – calculated curve	128
5.22	Dependence of the effective coefficient of thermal conductivity of the investigated coating on the temperature found by solving the inverse problems of thermal conductivity: T1 – by thermocouple located at a distance of 100 mm from the upper edge of the fire-retardant plate; T2 – according to the thermocouple located in	

## LIST OF FIGURES

---

	the center of the fireproof plate; T3 – according to the thermocouple located at a distance of 100 mm from the lower edge of the flame retardant plate	129
5.23	Dependence of the effective thermal conductivity of the coating on the temperature found by solving the inverse problems of thermal conductivity on the indicators of two thermocouples in different combinations	130
5.24	Dependence of temperature on the time of fire exposure from the unheated surface of the coated sample: <i>a</i> – for combinations of thermocouples T2–T3 and T1–T3; <i>b</i> – for combinations of thermocouples T2–T1; 1 – experimental curve; 2 – calculated curve	131
5.25	Dependence of the effective coefficient of thermal conductivity of the coating on the temperature found by solving the inverse problems of thermal conductivity, according to the indicators of three thermocouples	132
5.26	Estimated finite element model of the system “steel structure – fire-retardant coating”	133
5.27	Temperature distribution in the model “steel structure-fire-retardant coating with maximum thickness” after 25 minutes of testing under conditions of standard fire temperature	134
5.28	Dependence of the average temperature on the unheated surface of a steel structure with a fire-retardant coating on the time of fire exposure according to the standard temperature of the fire (minimum value of the coating thickness): 1 – obtained experimentally; 2 – obtained by simulation in ANSYS	135
5.29	Dependence of the average temperature on the unheated surface of a steel plate with a fire-retardant coating (maximum thickness) on the time of fire exposure to the standard temperature of the fire: 1 – obtained experimentally; 2 – obtained by simulation in ANSYS (heat transfer coefficient from the unheated surface of a steel structure with a coating of 5 W/(m <sup>2</sup> ·°C); 3 – obtained by simulation in ANSYS, the heat transfer coefficient on the unheated surface of a steel plate with a coating of 9 W/(m <sup>2</sup> ·°C)	135
5.30	Determination of adhesive strength by the method of swelling of the film: 1 – adhesive; 2 – substrate	137
5.31	Installation for determining the adhesive strength of coatings of fire-retardant steel structures	137
5.32	Scheme of the installation to determine the adhesive strength of the coating: 1 – plate; 2 – frame; 3 – substrate; 4 – hole; 5 – coverage; 6 – safety cover; 7 – seals; 8 – fitting; 9 – compressed gas supply mechanism; 10 – manometer	138

## CIRCLE OF READERS AND SCOPE OF APPLICATION

The monograph will be of interesting to applicants for higher education, scientists and practitioners in the field of "Civil Security" in the specialty "Fire Safety". The interest of the presented scientific results is that for the first time the problem of ensuring fire resistance of reinforced concrete and steel building structures is comprehensively solved in the work. The proposed computational and experimental methods, which are universal and based on multifactor models, allowed to achieve this. The monograph will be interesting for all regions of the world.

Designed for professionals and scientists engaged in scientific and practical activities in the field of fire safety, as well as scientific, scientific and academic staff and applicants for higher education in the field of "Fire Safety", as well as professionals who at the scientific and practical level ensuring fire safety of civil and industrial facilities.

## INTRODUCTION

In today's world, the need for security is of paramount importance. The development of mankind has led to the emergence of new man-made and natural threats [1]. Increasing the intensity and expanding the range of such threats requires the development of new approaches to ensuring the safety of human life and national security in general [2].

The most numerous and dangerous events are fires. There are about 8 million fires in the world every year, killing up to 100 000 people. This requires both increasing the readiness of rescue units to act as assigned and the development of preventive measures to prevent or mitigate the consequences of such events [3]. The greatest interest in this regard is the experience of the United States, where effective multidisciplinary structures of the threat response system have existed for half a century.

The impact of fires on humans and the environment is complex and is characterized by the action of the following interrelated primary to secondary factors [4].

Climate change on the planet leads to large-scale fires, which are very powerful sources of environmental pollution and lead to environmental disasters [5]. Often such fires due to air pollution [6] provoke acid rain [7], which in turn leads to pollution of rivers, groundwater and aquifers [8, 9]. On a global scale, fires further exacerbate the "greenhouse effect".

Along with landscape fires, fires in radiation-contaminated ecosystems are a particularly dangerous type of threat [10]. The Chernobyl Exclusion Zone is no exception [11]. At the same time, these events are both a local danger for ecosystems and a regional one for the population and the environment in a large area [12, 13].

Globalization in the world leads to the strengthening of man-made factors [14]. In modern conditions, the problem of protection of the population and territories from emergencies of natural and man-made nature, as well as from military dangers becomes especially important. This is due to the annual steady increase in the number and scale of disasters, a significant increase in human and material losses.

Improving the fire safety of buildings and structures is one of the most important components of protecting the population and the economy from modern threats. Fires and explosions at such facilities are dangerous not only for human health, but also significant financial losses associated with the elimination of the consequences of destruction and recovery of facilities [15].

Another factor is the emergence of new substances and materials [16]. New construction technologies involve the widespread use of various building materials and structures [17], the use of which provides mandatory regulatory requirements for compliance with the safety of operation of buildings and structures [18].

Despite technical progress in construction and firefighting technologies [19, 20], the fires have not become less dangerous [21]. Fires claim thousands of lives and cause billions in damage.

About 51 % of all fires in the world occur in buildings and structures and in transport. At the same time, 90 % of all victims of fires die on the premises.

These factors create a need to protect people from the impact of the identified threats. One of the most dangerous factors is fires in buildings and structures [22].

The risk of fires in buildings and structures arises due to disruption of normal operation of electrical appliances, gas leaks, careless handling of flammable and explosive substances, imperfections of technological processes, lightning discharge and application of high-temperature potentials.

Fire protection is provided by technical means [23] and organizational measures aimed at preventing exposure to fire hazards [24]. Such factors lead to burns, poisoning, injury or death, as well as material, social and environmental damage [25].

When burning in the room for the first 10–20 minutes, the fire spreads linearly along the combustible material. The room is filled with smoke, and it is impossible to see the flames. The room temperature rises exponentially to 300 degrees Celsius. This is the ignition temperature of the vast majority of materials [26]. After 20 minutes, the fire starts to spread. In 10 minutes, there is a destruction of glazing. The inflow of fresh air increases, the development of fire sharply increases. The temperature reaches 900 degrees. The burnout phase occurs. The maximum combustion intensity is reached within the next 10 minutes. After the main substances burn out, there is a phase of fire stabilization. If the fire cannot spread to other rooms, the fire goes outside. At this time there is a collapse of damaged building structures [27].

Ensuring the safety of people and property must be performed taking into account all stages of the life cycle of facilities, such as scientific support and monitoring [28], design, construction, operation, as well as to exclude fires [29, 30].

Technical means and organizational measures prevent the occurrence of fire, in which the probability of occurrence and development of fire does not exceed the standard allowable value [31, 32].

One of the factors on which fire safety is based during the design, construction, reconstruction, and change of functional purpose of buildings and structures for various purposes is to ensure fire resistance of building structures. The condition for reducing the irreversible consequences of fires at various facilities is the preservation of the bearing capacity of buildings, structures of technological structures and communications.

These stability requirements are provided by a set of measures provided for both production technology and the use of effective fire-retardant coatings for fire protection of building structures [33]. Fire-retardant coatings are presented in a wide range, the analysis of characteristics and parameters of which requires a detailed study.

Therefore, in the context of globalization and increasing threats to humans, the first place is played by maintaining the resilience of buildings and structures in the cases of fires and other natural disasters, as well as preserving their functional purpose after such impacts.

Creating the basis for effective assessment of fire resistance of fire-retardant reinforced concrete and steel structures with scientifically sound parameters of fire-retardant coatings is



an urgent problem, the solution of which will increase the accuracy of calculation of non-stationary heating of fire-retardant reinforced concrete and steel structures with sufficient research and the results of numerical simulations in modern software packages.

Existing fire safety regulations do not always meet modern challenges. As an example, tests to assess the effectiveness of fire protection and fire resistance of fire-retardant structures are carried out under conditions of standard fire temperature, which in most cases is not performed. Therefore, there is a risk of intense fires with high temperature and speed of spread (over 900 degrees for 5 minutes) [34], which may be accompanied by heat stroke of flames on structures and destruction of buildings.

These factors and contradictions indicate the urgency of solving the scientific problem in the field of fire safety, which is to develop a scientific basis for fire resistance of reinforced concrete and steel structures in modern extreme conditions.

**ABSTRACT**

---

The section analyzes the current state of fire resistance of reinforced concrete and steel building structures. The requirements to building constructions from the point of view of fire safety are described. An analysis of statistics on emergencies and fires associated with the loss of fire resistance. Modern approaches to ensuring fire resistance of building structures are considered. The most effective measures to increase the fire resistance of building structures have been identified. Fire-retardant materials used to increase the fire resistance of reinforced concrete and steel building structures are described. The conclusion about the current state of ensuring fire resistance of reinforced concrete and steel building structures is made. Ways to increase fire resistance are suggested.

**KEYWORDS**

---

Fire resistance, emergency, fire, buildings and structures, ensuring fire resistance.

**1.1 FIRE RESISTANCE OF BUILDING STRUCTURES AS A CONDITION FOR SAFE OPERATION OF BUILDINGS AND STRUCTURES**

Modern building structures designed and manufactured in accordance with current requirements can be operated for decades. However, in a fire, such structures are destroyed within hours or even minutes [35].

In case of fire, the violation of the overall stability of the building occurs due to the destruction of individual elements in the frame of the building. The risk of collapse of load-bearing structures, in addition to material damage, also endangers the lives of site workers during evacuation and rescuers during firefighting. In the vast majority of cases, the destruction of structures leads to the complete destruction of property, engineering and technological equipment. Therefore, maintaining the load-bearing capacity of building structures in the event of a fire for a given time is an urgent problem [35].

The indicator of fire resistance of building structures is their limit of fire resistance, which is determined by the time from the beginning of the test on the temperature of the fire to the onset of one of the normalized for a particular structure of the limit states.

To assess the compliance of building structures with the normalized value of the limit of fire resistance of the building structure, the procedures for assessing compliance and the procedure

for their application [36] and the basic requirements for building structures. The following requirements are aimed at ensuring:

- safety of human life and health [37–39];
- safety of building operation [40];
- mechanical resistance and stability of the building as a whole and individual building structures of this house [41];
- fire safety of the building;
- environmental protection [42–44].

Implementation of the principles of fire safety in construction is based on an engineering approach to assessing the required level of safety in the design, construction, reconstruction, technical re-equipment, overhaul, change the functional purpose of buildings and structures. The main requirements of fire safety in construction include the condition of limiting the spread of fire, smoke and maintaining the load-bearing capacity of the structure for a specified period of time [45]. An important area of ensuring these principles is to ensure the standardized fire resistance of reinforced concrete and steel building structures, by complying with the rules for their manufacture, development of effective methods and means of fire protection and assessment of fire resistance of such structures.

In accordance with European standards, there are the following types of limit states of building structures for fire resistance (**Fig. 1.1**):

- limit state on the basis of loss of bearing capacity (conditional letter designation *R*);
- limit state on the basis of loss of integrity (conditional letter designation *E*);
- limit state based on loss of heat-insulating ability (conditional letter designation *I*).

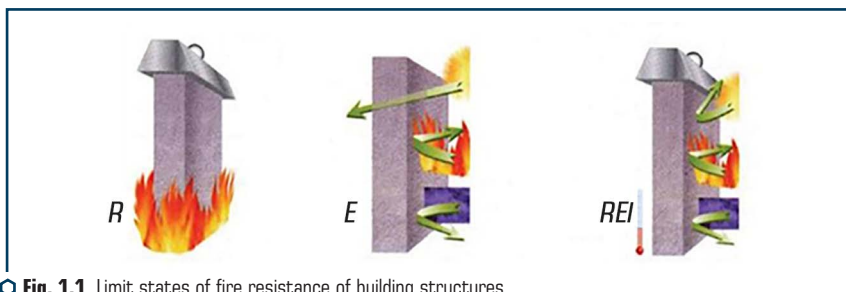

**Fig. 1.1** Limit states of fire resistance of building structures

The limit state based on the loss of bearing capacity *R* occurs when the sample collapses or the occurrence of boundary deformations.

The limit state on the basis of loss of integrity *E* is a state in which one of the conditions is met:

- ignition or smoldering with the glow of a cotton swab raised to the unheated surface of the sample in places of cracks at a distance of 20 to 30 mm for a period of time not less than 30 s;

- the occurrence of a crack through which you can freely (without additional effort) insert into the furnace a probe with a diameter of 6 mm and move it along this crack at a distance of at least 150 mm;
- the occurrence of a crack (or hole) through which you can freely enter the probe with a diameter of 25 mm;
- a flame is observed on the unheated surface of the sample for at least 10 s.

The limit state based on the loss of thermal insulation capacity  $I$  is the excess of the average temperature on the unheated surface of the sample above the initial average temperature of this surface by 140 °C or the excess temperature at any point of the unheated surface of the sample above the initial temperature by 180 °C.

Building structures depending on the normalized limit states of fire resistance and fire resistance limits are divided into classes of fire resistance. The designation of the class of fire resistance of building structures consists of conditional letter designations of limit states ( $R$ ,  $E$ ,  $I$ ) and the number corresponding to the normalized limit of fire resistance in minutes, from a number: 15, 30, 45, 60, 90, 120, 150, 180, 240, 360.

The values of the limits of fire resistance of building structures that make up the building, significantly affect its architectural solution and building parameters as a whole.

To assess the compliance of building structures with the normalized value of the fire resistance limit, various methods and approaches have been developed to ensure fire resistance of fire-retardant reinforced concrete and steel building structures and the procedures for conformity assessment and the procedure for their application have been determined.

Fire resistance of building structures and their elements, protected by fire-retardant coatings, is normalized and determined by tests for fire resistance at standard fire temperatures, which does not always meet modern fire safety requirements for buildings and structures.

For example, in industrial facilities, fires are characterized by a rapid rise in temperature to 1100 °C at the beginning of its development due to the high fire load.

Assessment of fire resistance can be performed by calculation and experimental methods according to standards or developed methods. Experimental methods involve full-scale fire tests of building structures, fragments or the building as a whole [46–49].

In [46] the methodology of checking the fire resistance of a fragment of a building under the influence of fire was developed to substantiate the main provisions of the calculation methodology and determine the residual bearing capacity. The approach implemented in the LIRA-SAPR software package allows to take into account the influence of changes in the operating mode on the stress-strain state of the structure. In this case, the approach does not provide for thermal calculation of a fragment of the building.

[47] describes the results of an experiment conducted to develop a method for determining the strength characteristics of reinforcement by the method of “threading” after temperature effects. However, the thermal calculation of fire-retardant reinforced concrete and steel structures is not described.

In the article [48] the results of numerical modeling of tests on fire resistance of bearing walls executed with use of various configurations of fire furnaces are presented. Using a computer simulation of gas and liquid flows, a temperature gradient was obtained for the heated surfaces of the load-bearing walls and the temperature distribution was calculated for a specific point in time of the computational experiment. However, the presented method does not describe its application to other building structures than load-bearing walls.

During the research [49] a scientifically substantiated sequence of procedures with a detailed selection of equipment and test samples to obtain reliable experimental data in the study of the temperature of the fire in the cable tunnel. There are no experimental data for other temperature regimes of fires.

As can be seen from the analysis [46–49], the conditions for ensuring fire resistance are:  
– by time parameters:

$$t_{fi,d} \geq t_{fi,requ}, \quad (1.1)$$

where  $t_{fi,d}$  – estimated limit of fire resistance, min;  $t_{fi,requ}$  – normalized limit of fire resistance, min.

– by strength parameters:

$$R_{fi,d,t} \geq E_{fi,d,t}, \quad (1.2)$$

where  $R_{fi,d,t}$  – the estimated value of the bearing capacity of an individual structure during a fire at a specific time  $t$ , kN;  $E_{fi,d,t}$  – the estimated value of the load effect during a fire at a specific time  $t$ , kN;

– by temperature parameters:

$$\Theta_d \leq \Theta_{cr,d}, \quad (1.3)$$

where  $\Theta_d$  – the estimated value of the material temperature, °C;  $\Theta_{cr,d}$  – the calculated value of the critical temperature of the material, °C.

The strength and rigidity of steel and reinforced concrete structural elements decrease with increasing temperature. Reducing such characteristics is especially important in the temperature range between 400 and 700 °C. The simplest way to calculate steel structures under fire conditions is to calculate the building for normal environmental conditions, and then verifying that the temperature of the steel elements of the structures coated with flame retardants does not exceed a certain critical value or does not exceed a certain percentage of the load-bearing capacity of the structure at the temperature of the fire.

Thus, to ensure the normalized values of the limits of fire resistance of reinforced concrete and steel building structures, it is proposed to use various approaches and tools: increasing the

protective layer of concrete, plastering, design measures, use of water as a coolant. However, recently, methods of increasing the fire resistance of reinforced concrete structures through the use of fire protection systems have become more widespread.

Modern approaches to ensuring the safety and stability of buildings and structures in the case of fire (for example, Eurocodes) involve the use of alternative calculation methods based on the performance of materials and structural elements.

Necessary operational characteristics of structures in the conditions of fire are accepted, as a rule, on tabular values which provide the minimum sizes and the minimum thickness of a covering of the set limit of fire resistance [50].

Part 1-2 of EN 1992 applies to the design of reinforced concrete structures in the event of an emergency during a fire and is intended for use in conjunction with EN 1992-1-1 and EN 1991-1-2. Part 1-2 identifies differences or complements design requirements at normal temperatures. Part 1-2 of EN 1992 applies only to passive fire protection methods. Active methods of protection are not given. Part 1-2 of EN 1992 applies to reinforced concrete structures that must perform specific functions during a fire:

- prevention of premature destruction of the structure (bearing capacity);
- limiting the spread of fire (flame, hot gases, overheating) outside certain areas (enclosing capacity).

National standards implementing the Eurocodes contain the full text of the Eurocodes (including all technical additions) as published by the European Committee for Standardization. The text of the Eurocode itself is preceded by a national title page and a national introduction, followed by national annexes. National annexes contain only information on those parameters that are left open in Eurocodes so that they can be selected at national level. These parameters are known as nationally defining parameters. They are used to design buildings and perform construction work in the country that introduced them.

The analysis of the current state of ensuring the safety of buildings and structures for industrial and civil purposes has shown the presence of contradictions that arise in the process of analyzing the conditions for ensuring fire resistance of fire-resistant building structures. Resolving these contradictions will create conditions for the safe operation of buildings and structures using fire-retardant reinforced concrete and steel structures with scientifically sound parameters of their fire-retardant coatings.

## 1.2 FIRE SAFETY REQUIREMENTS FOR BUILDING STRUCTURES USED IN MODERN CONSTRUCTION

The limit of fire resistance of a building structure depends primarily on the properties of materials and manufacturing technology of such a structure, its size, conditions and magnitude of the applied load, the presence of fire protection elements, as well as the parameters of fire [51].

In [52] the results of estimation calculations of bearing capacity, critical temperatures and indicators of fire resistance of bending reinforced concrete elements on the basis of fibroconcrete with dispersed reinforcement from steel, basalt and synthetic fiber are given. Calculations performed on the example of a reinforced concrete rectangular beam, taking into account the percentage of reinforcement of each element, and at constant load, which corresponds to the condition of adequacy of the calculation. It is shown that the dispersed reinforcement of the bending reinforced concrete element with steel, basalt and synthetic fiber increases its bearing capacity, but has little effect on the critical temperature and the limit of fire resistance. The presented results of estimation calculations allow to predict the use of bending reinforced concrete elements based on concrete with dispersed fibers depending on the content of reinforcement and load. However, the work does not consider other reinforced concrete structures, except for the beam.

In [53] the results of experimental studies of the impact strength of concrete and reinforced concrete samples are presented. It was found that the impact strength increases significantly in the presence of fiber, but the type of fiber has little effect on it. Because specimens reinforced with a fiber content of 1.0 and 1.5 % differ slightly in impact strength, 1.0 % volumetric reinforced reinforcement is recommended for both static and dynamic loads. The disadvantage of the study is the lack of results of experimental studies of the samples in the furnace at a given temperature of the fire.

In [54] the results of the research of behavior of the reinforced concrete beam which was exposed to fire with application of a standard temperature mode of fire are resulted. Based on the results of the study, the practice of assessing the fire resistance of reinforced concrete beams based on the experimental calculation method was developed and tested. The sequence of procedures of the strength calculation method based on temperature measurement in the inner layers of reinforced concrete beams is demonstrated. The fire resistance of the considered reinforced concrete beams was evaluated based on the interpretation of the data obtained during the fire resistance tests and the use of the proposed method of calculating the strength. However, the proposed method does not describe the sequence of procedures for other building structures and other fire temperatures.

[55] proposed a calculation method for estimating the possibility of progressive failure, based on the assumption that one or more compressed elements are damaged and must be removed from the system, which provides rigidity and geometric invariance. The main point of the method is the hypothesis of forming a line of plastic hinges in the ceiling plate. The assessment of the possibility of progressive destruction is carried out according to the energy criterion on the basis of comparing the work of internal and external forces in relation to the possible movements of the system, which under these conditions is geometrically variable. The proposed method is productive and economical compared to existing methods, which include complex mathematical models and software packages. The paper does not describe how exactly the line of plastic hinges in the plate is formed: from stroke or fire.

However, to ensure the normalized values of the limits of fire resistance of reinforced concrete structures of the above objects to 150–180 minutes or more, it is usually necessary to increase the thickness of the protective layer of concrete in structures up to 50–70 mm. This increase in the thickness of the protective layer of concrete minimizes the positive properties of high-strength concrete and structures, because it leads to an increase in the mass of the building structure, the load on the building and to reduce the area of the premises [56]. The disadvantages of structural concrete also include such a phenomenon as explosive destruction under the action of temperature, which in a fire can reduce the working cross section of the structure and reduce its limit of fire resistance to complete loss.

Recommendations for preventing the explosive destruction of concrete structures include measures to include in the structure of reinforced concrete certain fillers, special metal mesh, which prevents the chipping of large pieces of concrete [57]. The implementation of this approach causes a change in the formulation of reinforced concrete, which can affect its strength properties [58].

However, no less important aspect of the destruction of structures due to fire is the avalanche-like destruction of buildings and structures. There are many examples of such fires in the world, and most of them took place in reinforced concrete buildings and structures. Such emergencies arise due to mistakes made in the design of the building, deviations from the project during construction works, violation of installation rules, during commissioning of the building or its separate parts with major shortcomings, in violation of the rules of operation of the building, as well as due to natural or man-made extraordinary events.

In the technical aspect, there is a problem of protection of objects (buildings and structures) from the progressive collapse in emergencies (strokes, explosions, fires).

The authors of the study [15] consider the creation of fire barriers arising from the explosion of special charges. The efficiency of the shock wave is increased by increasing the pressure pulse, which allows to increase the width of the fire barrier to 8 m. The study shows the dependence of the width of the fire barrier on the parameters of special charges.

In [59], calculations on the example of a steel column showed the combined effect of an explosion that causes deformation and subsequent ignition, even without damaging the flame retardant coating. As a result, there is a significant reduction in the limit of fire resistance of the structure by reducing the critical temperature. It is shown that based on the proposed method for hazardous production facilities it is possible to predict the resistance of steel columns to stroke effects with subsequent combustion, as well as to recommend the values of workloads and parameters of fire-retardant coatings that provide the required stability. However, from studies [15, 59] it is not clear how the technique can be applied to steel building structures working to the bend.

In [60], the influence of non-equilibrium excitation of molecules on the direct initiation of detonation by a spark discharge was investigated, which was evaluated by comparing the simulation result considering the vibrational excitation. It has been established that the increase in the critical energy of detonation initiation is associated with a delay in the activation of the vibrationally excited states of polyatomic molecules in the initiation of the shock wave. However, the issue of ensuring



fire resistance of building structures through the use of fire-resistant building structures with standardized parameters is not disclosed.

In [61], a study was conducted to numerically evaluate the mitigating effects caused by the gas station wall to protect personnel from the effects of a gas explosion. An assessment of the optimal location of the wall and the selection of appropriate material for the wall. Computer technology for determining the probability of personnel injury based on the analysis of the blast wave has been developed. The developed technology allows to carry out the automated analysis of a safety situation at gas stations and the analysis of efficiency of various types of materials from which means of protection are made. At the same time, the paper does not disclose the issue of further combustion due to fire and the effect of high temperatures on the fire resistance of building structures. The collapse can often be facilitated by an explosion as a result of a terrorist act, improper operation of domestic gas pipelines, careless handling of fire, storage of flammable and explosive substances in buildings.

Therefore, research and development of ways to increase the fire resistance of building structures, devoid of these shortcomings, is an urgent problem, the solution of which will ensure the safety and stability of buildings and structures in the combined effects.

An indispensable attribute of modern construction is the use of steel structures. Such structures are widely used in the construction of various buildings and structures. Due to the significant strength and density of the metal, the efficiency of connection of elements, a high degree of industry, manufacture and installation, steel structures are characterized by relatively low weight, gas and water resistance, provide rapid installation of buildings and structures and accelerate their commissioning [62]. Thus, all steel designs at achievement of a certain temperature in the conditions of a fire lose a part of the bearing capacity. The strength of steel at high temperatures was studied in detail and it was determined that at a temperature of approximately 500–550 °C, the steel bears 60 % of the design load under normal conditions. Thus, 500 °C is considered the critical temperature that a building made of steel structures can withstand. At the same time, recent studies have shown that the failure temperature of the steel element of the building is not rigidly fixed at 500 °C but varies depending on two factors – the heating temperature of the element and the load applied to it [62–65].

In [62], the critical temperature varies from 100 °C to 400 °C and more, using the experimental values of the thermal conductivity of the fire-retardant coating obtained for the conditions of the standard temperature of the fire. However, the study is limited to a critical temperature of 400 °C, although it can reach a temperature of 750 °C.

In [63], in addition to the standard temperature regime of the fire, the external fire mode is also used during the tests.

In [64], the performance characteristics of reactive flame retardant coatings were studied using four heating curves with different maximum temperatures (standard temperature curve, hydrocarbon fire curve and two self-reproducing curves with reduced temperature). At the same time in [63, 64] the issues of using other arbitrary fire regimes remained unresolved.

The authors [65] present the results of an experimental study of two types of reactive fire-retardant coatings for steel structures that were exposed to the standard temperature of the fire, and three non-standard combustion curves. As a result, it was found that the constant effective thermal conductivity of the fire-retardant coating in non-standard fires was 65 % and 35 % higher than in a standard fire, which led to an overestimation of the destruction time of the coating to 15 and 11 minutes, respectively. Therefore, it is sometimes dangerous to use the results of standard tests for fire resistance, which determine the calculation of the coating thickness of fire-retardant steel elements in non-standard fire conditions.

[66] presents a general procedure for modeling the thermal state of a fire-retardant steel structure. The procedure allows the use of both simplified and extended calculation methods. However, no justification is provided for the use of laboratory test results for their use in full-scale tests.

By purpose, steel beams are divided into main (longitudinal, overlapping the run between the supports) and auxiliary (transverse, overlapping the distance between the main beams) (**Fig. 1.2**).



◉ **Fig. 1.2** General view of the steel beam

Steel trusses are three-girder geometrically invariant structures consisting of rectilinear rods. Even though the rods in the nodal trusses are rigidly connected by welding, bolts, rivets or are a monolithic structure, experiments show that the bending moments in rectilinear rods are much smaller compared to longitudinal forces. Therefore, in practical calculations, bending moments are neglected and when constructing the calculation scheme of the truss, it is assumed that ideal cylindrical hinges are installed in the nodes (**Fig. 1.3**).



○ Fig. 1.3 General view of the steel truss

Columns are vertically arranged rod elements that transfer loads from the upper structures to the foundations. In columns distinguish: the top part – a head on which the above-placed designs lean; the rod – the main part of the column, which transmits the load from top to bottom, and the base (shoe) – the lower part of the column, which transmits the load from the rod to the foundation (Fig. 1.4).



○ Fig. 1.4 General view of metal columns

If the column works to absorb the load from a single longitudinal force applied to the center of gravity of the section, it is called centrally compressed. If the longitudinal force does not coincide with the center of gravity of the section or transverse loads are applied to the rod, then in addition to compression there is a bend, and the column is called eccentrically compressed.

Solid and tied columns with a rod of constant cross section are most common in central compression. Solid columns are used at high loads and low altitudes, tied, on the contrary – at lower loads and high altitudes.

Thus, the limit of fire resistance of unprotected steel structures without fire protection is insufficient. Accordingly, without determining the fire resistance of steel structures, the design of construction objects is more than abstract, after all, as is the level of fire safety of the object as a whole [67]. In addition, the use of one or another method of fire protection is associated with significant economic costs and in some cases reaches 20 % of the total cost of construction.

[68] presents a block diagram showing the advantages of thermal spraying methods of protective coatings and the main factors influencing the structure and properties of the coating. The authors propose a procedure for preliminary evaluation of the effectiveness of coatings and the corresponding method of thermal spraying. The criterion assessment of the improvement of the characteristics of the details of the design of the aircraft with thermal spraying is proposed to be implemented within the conceptual approach, which involves the use of an integrated efficiency criterion, including single, group and complex components. However, the researchers did not pay attention to the issues of determining the effectiveness of coatings by determining the properties and their scientific justification.

Therefore, the definition of fire-retardant ability for passive fire-retardant coatings will increase the competitiveness and reduce the cost of such materials [69].

An effective way to increase the fire resistance of steel structures is the use of reactive (swellable) fire-retardant coatings [70, 71].

In [70] the determination of fire resistance of fire-retardant steel structures protected by reactive fire-retardant coatings depending on the simulated operating conditions and atmospheric factors affecting the materials during a certain period was done. However, there are no data on changes in the thermophysical characteristics of coatings after exposure to climatic factors.

In [71] a practical engineering model for determining the flammability properties and predicting the fire-retardant ability of reactive coatings by conducting experiments on a steel substrate with a thickness of 5 mm in a conical calorimeter is presented. However, there are no data on the behavior of such a coating for fire protection of steel structures when tested for fire resistance in special test furnaces.

In [72] the processes of loss of integrity of fire-retardant facing from glass wool of steel I-beam are considered. The relationship between the integrity of the fire-retardant shell and its thermal insulation capacity has been studied. It is shown that fire-retardant cladding loses its integrity under the thermal influence of fire long before the onset of the limit state of loss of fire resistance in terms of load-bearing capacity.

There are a significant number of algorithms and methods of fire protection of building structures, and the choice of the correct solution that allows to minimize costs and achieve effective project implementation [73, 74].

The work [73] is aimed at developing new and optimizing existing experimental approaches to determine the fire-retardant ability of coatings, starting with furnaces that consider radiation and convective heat exchange.

In [74], experimental studies of the characteristics of reactive coatings in standard and non-standard fire conditions are described using experimental installations corresponding to three different combustion scenarios. This does not provide data on the accuracy of new and existing approaches in determining the fire resistance of fire-resistant steel structures.

Given the large number and versatility of the described factors, ensuring the fire resistance of load-bearing elements of reinforced concrete and steel building structures is an important and quite complex problem. Solving this problem will allow at the stage of design, construction and operation of buildings and structures to ensure their stability in high temperature or destruction due to disruption of the normal cycle of operation of the object.

### 1.3 ANALYSIS OF STATISTICAL DATA

#### 1.3.1 FIRE STATISTICS

There are more than 250 countries in the world today, in which more than 7 billion people live. About 8 million fires occur each year, killing about 90 000 people.

About 51 % of all fires occur in buildings and structures and on transport, and such fires kill the majority (90–95 %) of fire victims. The exceptions are Barbados, Poland and Portugal, where fires in buildings and transport account for less than 22 % of the total, and Lithuania and Estonia for less than 30 %. However, in Russia, Ukraine and Singapore, fires in buildings and vehicles account for at least 75 % of the total. The number of fires in Ukraine that occurred in buildings and structures during 2007–2020, on average, is 52.7 % of the total, and the number of deaths – 95.5 %.

#### 1.3.2 ANALYSIS OF EMERGENCIES AND FIRES ASSOCIATED WITH LOSS OF FIRE RESISTANCE

Despite technical progress in construction and fire-fighting equipment, fires have not become less dangerous today. Large-scale fire tragedies are still claiming thousands of lives and causing millions in damage. The following resulted in a fire in Sao Paulo (February 1, 1974) in a 24-storey building on the 12th floor, which killed 179 people and injured about 300; a fire at

the “Russia” hotel in Moscow on February 25, 1977, claiming 42 lives. A fire in Karamay, China, broke out in the palace of culture “Friendship Hall” on December 8, 1994, killing 323 people, including 288 children. A fire broke out in two twin skyscrapers of the World Trade Center in New York as a result of the terrorist attack of September 11, 2001, which led to their collapse and death of about 3 thousand people. A fire in the “Windsor” skyscraper in Madrid on April 14, 2005, led to the complete collapse of the building's structures.

On the night of June 16, 2009, a mazut flare burning occurred at a refinery in Komso-molsk-on-Amur as a result of depressurization of the flange connection. The fire was extinguished in two hours, no one was injured or killed.

On December 27, 2010, an explosion occurred at the oil refinery of Trans-baikal Oil Refinery LLC in the village of Dauria in Transbaikal. The blast killed five people, all five citizens of the People's Republic of China, who were at the epicenter of the blast. The reprocessing facility was destroyed by 90 % because of the explosion and further development of flare burning.

The causes of the fire at the Saratov Oil Refinery (**Fig. 1.5**) on October 4, 2012 was a leaky overlap of the valve assembly. As a result, there was an emission of the vapor-gas phase of the gas oil from the drain valve with subsequent ignition and the occurrence of flare burning.



○ **Fig. 1.5** Fire at the Saratov Oil Refinery on October 4, 2012

A fire on the “Abkatun Alfa” oil platform in the Gulf of Mexico killed 15 people and more than 50 were injured. Material damage is estimated at tens of millions of dollars.

Material damage from the fire in the reservoir park of the “Usa” oil treatment plant (Republic of Komi, May 21, 2014) amounted to more than 53 million RUB (**Fig. 1.6**).



○ **Fig. 1.6** Fire in the reservoir park of the “Usa” oil treatment plant (Komi Republic, May 21, 2014)

In June 2014, there was an accident at the Achinsk refinery. The explosion of hydrocarbon gas at the gas fractionation plant led to a flare, followed by the spread of the fire to an area of 400 square meters. As a result of this incident, 8 people died and 24 were injured. The damage from the fire is estimated at \$ 800 million and is one of the largest insurance losses in the world in the oil and gas industry (**Fig. 1.7**).



○ **Fig. 1.7** Destruction of structures because of the accident at the Achinsk refinery in June 2014

The most frequent progressive collapse is observed when exposed to the construction of buildings and structures temperature effects of fires (**Fig. 1.8**) [75, 76].



○ **Fig. 1.8** Progressive collapse of metal structures of the building because of fire

[75] describes the engineering aspects of the terrorist attack on the towers of the World Trade Center of the United States in 2001. In [76] the probabilistic methodology based on the thermomechanical analysis of finite elements from the research of influence of variability of thermal properties of concrete on fire safety of designs and the building as a whole is presented.

On August 28, 2019, in the city of Drohobych, Lviv region, probably due to an explosion (detonation burning), the entire entrance of a four-storey building collapsed. According to the State Emergency Service in Lviv region, it was a four-storey brick house, built in 1960, with 64 apartments. The second entrance collapsed, in which there were 15 apartments and a hairdresser's: 7 apartments were destroyed (4 one-room, 3 three-room and hairdresser's premises), 8 apartments (3 two-room, 5 three-room) were damaged. In the Russian Federation from 1995 to 2006 there were at least 7 cases of large collapses of buildings due to an explosion of domestic gas. Also, in 2015, part of the barracks near Omsk collapsed.

The Sampoong Department Store collapsed on June 29, 1995 in the Seochogu district of Seoul, Republic of Korea. This is the greatest peacetime catastrophe in the history of South Korea. As a result of the collapse of the building, 502 people died and 937 were injured. Prior to the September 11 terrorist attacks in the United States and the collapse of Rana Plaza in Bangladesh, it was the largest number of victims in the collapse of a building in modern world history (**Fig. 1.9**).

On the morning of January 31, 2020, the building of the St. Petersburg sports complex was demolished on Yuri Gagarin Avenue (Russian Federation). In its place they intended to build the largest ice arena in the world. In the process of dismantling there was a collapse (**Fig. 1.10**), which killed one person.





○ Fig. 1.9 Collapse of a 5-storey supermarket in Seoul, 1995



○ Fig. 1.10 Collapse of the St. Petersburg sports complex, January 31, 2020

On September 21, 2020, a three-story building collapsed in the city of Bhiwandi, located near the metropolis of Mumbai in India, killing 39 people (Fig. 1.11). The building in the suburbs of Mumbai collapsed on Monday at about 4:00 local time. After the collapse, local residents helped almost 20 residents get out of the rubble, and up to 25 people remained under the rubble.

As a result of a gas explosion on February 27, 2012 in a nine-storey residential building located in the city of Astrakhan, an explosion wave destroyed 4 first floors of the building (Fig. 1.12). When witnesses to the tragedy began to help the injured residents, the entrance fell completely.

As a result of the incident, 12 people were injured, including two children. Another 14 locals are missing. Eyewitnesses of the tragedy are convinced that the collapse of the entrance caused the death of people.

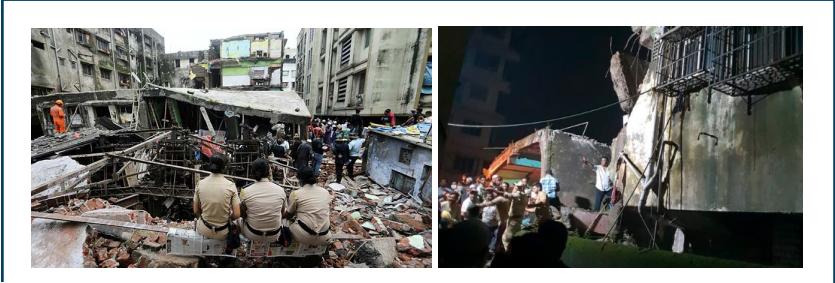

○ **Fig. 1.11** The collapse of a three-story building in Bhiwandi, India, on September 21, 2020

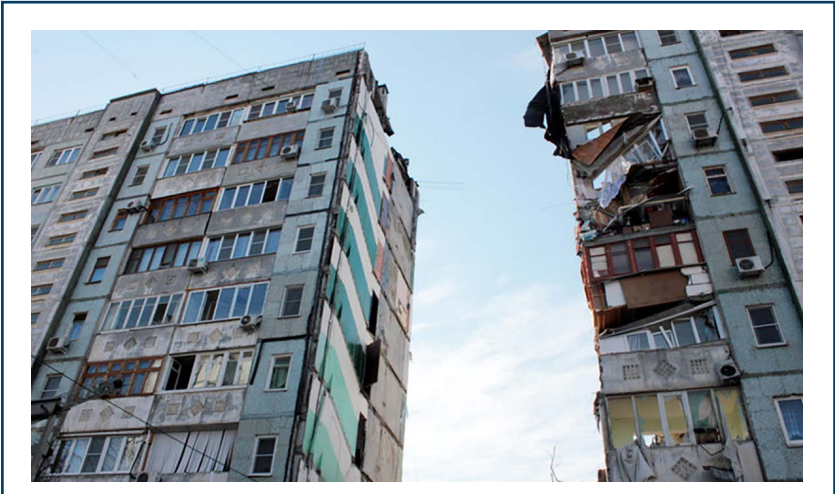

○ **Fig. 1.12** Collapse of a nine-storey residential building in the city of Astrakhan, February 27, 2012

On May 16, 2019, a building collapsed in Shanghai, killing 21 people. The incident occurred when the roof of the building fell. All the victims are workers who built a factory for a car dealership.

Analysis of statistics shows that the problem of protection against avalanche-like destruction of buildings and structures due to fires and explosions of household gas or detonation of ammunition is quite relevant. It requires a detailed study based on world experience and is reduced to design decisions in the design, taking into account the operation of building structures in emergency situations, including the use of fire-resistant building structures.

Schematically, the deformation of the floor slabs and interior walls of the panel building is shown in **Fig. 1.13**.

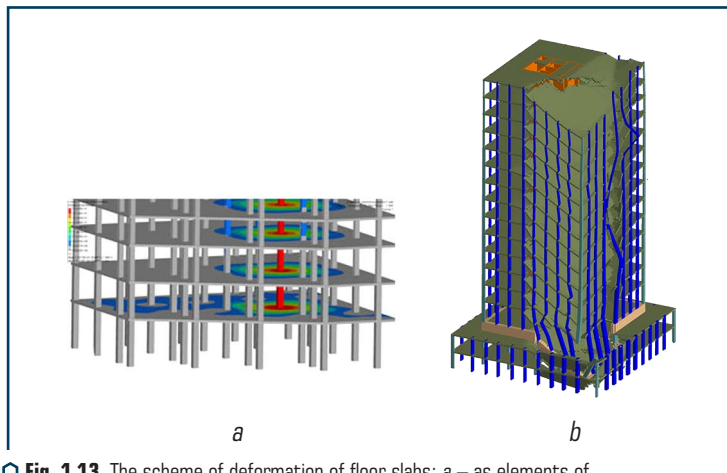

**Fig. 1.13** The scheme of deformation of floor slabs: *a* – as elements of the hanging system; *b* – the inner walls of a large-panel building

The most important characteristic that a building or structure should have is survivability, which means the property of the structure to provide its functional purpose partially or completely in the event of failure of individual structural elements [77, 78].

International fire safety standards for buildings and structures introduce special regulations for the time during which building structures, buildings and constructions must resist the combined effects of workloads and high-temperature fires [78]. This resistance time is linked in the norms with other elements of the fire protection system, such as fire barriers, gaps, evacuation procedures.

Analysis of the events of September 11, 2001 and other accidents showed that more attention should be paid to the progressive destruction in addressing the safety of facilities, including through the use of fire-retardant steel and reinforced concrete structures with scientifically sound and standardized parameters [79].

The analysis showed that a large number of emergencies, including fires, occur due to neglect or disregard in the design of fire resistance requirements for building structures that make up buildings and structures.

One of the factors on which fire safety is based during the design and operation of buildings and structures for various purposes is to ensure fire resistance of building structures and their ability to spread fire. New construction technologies involve the widespread use of a variety of building structures, the use of which usually involves mandatory regulatory requirements for compliance with the limits of fire resistance and fire propagation. These requirements can be provided by a complex or systems of a protective layer, which is provided both by production technology (reinforced concrete structures, sandwich panels) [80] and the use of reactive and passive fire-retardant coatings. Fire-retardant coatings are represented by a wide range of both domestic and foreign production, the analysis of the characteristics of which requires detailed study. Given the above, it is important to determine the effective means, technologies and methods for calculating the fire resistance of building structures and fire protection parameters of building structures.

### 1.4 MODERN APPROACHES TO FIRE RESISTANCE

One of the factors on which fire safety is based during design, construction, expansion, reconstruction, technical re-equipment, overhaul, change of functional purpose of buildings and structures for various purposes is to ensure fire resistance of building structures and their stability not to spread fire.

Fire protection of building structures is an integral part of the system of measures to ensure fire safety and fire resistance of buildings and structures.

The task of fire protection is to create on the surface of structures heat-insulating screens with low thermal conductivity, able to withstand high temperatures, as well as to insulate the surface of the structure from direct fire. Such screens allow to slow down warming up of a design that raises the actual limit of fire resistance and keeps its properties at a fire within the set period.

As a result of the research [81] the limit thresholds of the beginning of swelling from the point of view of temperature of steel are received, it is established that the beginning of swelling of a covering is directly influenced by heating conditions on an open surface and initial thickness of the put flame retardant. There are no reliable data on the heating conditions in the fire furnace of fire-resistant steel structures.

[82] described the testing of fire-retardant steel samples of reduced size in a hydrocarbon fire, which proved the effectiveness of the proposed laboratory furnace as an additional tool for industrial tests for fire resistance. However, the reliability of the results obtained on the samples of reduced size and the possibility of their application in large-scale tests have not been determined.

The study [83] is devoted to the development of fire-retardant substances that form coatings on steel structures and describes the effect of the main components of the developed compositions on the characteristics of fire-retardant such coatings. At the same time, the influence of thermophysical characteristics of coatings on the fire resistance of fire-resistant steel structures remained unresolved.

Flame retardants are used to increase the fire resistance of building structures – the ability of structures to maintain their load bearing and (or) protective functions during a fire [84–86].

In [84] the existing “traditional” formulations of fire-retardant compositions are improved, by means of substantiation of changes in compositions and technologies of manufacturing of initial compositions. At the same time, the influence of thermophysical characteristics of coatings on the fire resistance of fire-retardant steel structures remained unresolved.

[85] presents the results of a detailed evaluation of a method that can be used to predict the behaviour of reactive flame retardant coatings for steel structures and thermal conductivity in different conditions (changes in steel cross-sectional thickness, coating thickness and the nature of the fire).

However, the accuracy of the method and its adequacy in arbitrary fire conditions, and hence the effectiveness of the method are not given.

In [86], the fire resistance of building structures was predicted based on a model for the design of reactive fire-retardant coatings, which includes the thermophysical characteristics of the coating.

Fire-retardant materials do not have fire resistance separately from the building structures they protect. Therefore, the assessment of the fire resistance of these materials is associated with the assessment of fire resistance of protected building structures [87]. At the same time, the question of the correctness and accuracy of setting the parameters of fire-retardant coatings for thermal calculation remains open.

Thus, the assessment of fire resistance of building structures (individual structure, part of the structural system or structural system as a whole), including the use of fire-retardant substances, considers the following stages:

- selection of project fire scenarios;
- determination of the appropriate temperature regimes of the fire;
- determination of temperature increase (thermal state) in building structures and (or) stress-strain state of building structures in case of fire.

## 1.4.1 FIRE PROTECTION OF REINFORCED CONCRETE STRUCTURES

Fire protection of reinforced concrete building structures is an integral part of the system of measures to ensure fire safety and fire resistance of buildings and structures [88].

One way to reduce fire damage is to use fire retardant coatings. According to experts, there are no coatings that can protect the building structure from fire for a long time. The main purpose of their application is to delay the increase in temperature of the building structure and, accordingly, the loss of properties. The priority for foreign developers of fire-retardant coatings is to create new, more effective and improve existing fire-retardant materials that can significantly reduce the fire hazard of protected objects [89].

The most common materials used in passive fire protection include:

- structural fire-retardant materials – screens (plates, segments, bricks) based on non-combustible insulating and heat-absorbing materials – perlite, vermiculite, refractory fibers with fillers [90, 91];
- fire-retardant plaster mixtures of special composition, which increase the limit of fire resistance of steel and reinforced concrete structures up to 240 minutes;
- fire-resistant gypsum boards [92].

Fire-retardant plasters are, as a rule, cement-vermiculite composition with a complex of special additives, which forms a coating with high adhesive strength to concrete surfaces and relatively low density (240–400 kg/m<sup>3</sup>) [93]. The composition is delivered in the form of a dry construction mixture, which after adding water is applied in a mechanized way to obtain a coating with a thickness of 10–50 mm, depending on the required limit of fire resistance.

The mechanism of action of coatings of this type is to reduce the rate of heating of concrete or metal due to the insulating properties of the protective layer. The undeniable advantages of fire-retardant plasters include:

- high degree of fire safety, which consists in the absence of smoke and toxic combustion products;
- a large limit of fire resistance – up to 360 minutes or more, which exceeds the same figure for gypsum boards;
- relatively low cost of material.

Various fire-retardant coatings and facings can be used for fire protection of reinforced concrete structures. These materials have different thermophysical characteristics (density  $\rho$ , thermal conductivity  $\lambda$ , specific volumetric heat capacity  $c_p$ ), and, accordingly, may have different values of the required minimum thickness to ensure the normalized limit of fire resistance of reinforced concrete structure. The formulation of such fire-retardant materials is constantly improved, so it is very important to know the degree of influence of a coefficient on the fire-retardant ability of the coating or cladding, it is also necessary to take into account the influence of thermal conditions on the structure with fire protection [94, 95].

In [94], based on the developed refined method of calculating the load-bearing capacity of the reinforced concrete floor slab in case of fire, it is proposed to increase the fire resistance of reinforced concrete floor slab with perlite plaster with a reasonable thickness, which will increase the fire resistance limit 2 times. However, no data are provided on the accuracy of the method and its use in arbitrary fire conditions.

In [96], experimental studies of the fire-retardant action of the coating based on the gel-forming system at all points of the factor space were carried out. A regression equation is obtained, which describes the influence of qualitative and quantitative composition of the coating on its fire resistance.

The authors of [97] investigated the influence of the degree of homogeneity of the SiO<sub>2</sub> sol on the duration of the induction period and the quality of fire-retardant coatings. Prospects for the use of IR spectroscopy as an express method for studying the phase composition of the gel coating,

the degree of completion of the hydrolysis of the organosilicon component are shown. However, the researchers [97] did not pay attention to the influence of coating thickness on the fire resistance of fire-retardant reinforced concrete floors.

In [98], the height of the dry and wetted layers of foam glass required to stop the burning of one, two and three atomic alcohols was experimentally determined. It is concluded that alcohols can be quenched with dry and moistened foam glass, both with a layer of gel applied to its surface and without a layer of gel.

Plasters based on light fillers for small volumes of work can be applied using a manual plastering tool, but the most technological process is plastering by wet shotcreting. Shotcreting allows you to create fire-retardant coatings that accurately replicate the shape of the building structure, which is protected.

There are a large number of passive fire-retardant coatings for the protection of reinforced concrete structures.

Fire-retardant plaster composition "SOSH-1" (R 45-R 240) is a mixture based on a binder component with perlite sand produced by the company "Kroz". It is intended for protection against action of fire of bearing reinforced concrete constructions of high-rise buildings, transport tunnels, underground parking lots and garages. Provides fire resistance of reinforced concrete structures from 45 to 240 minutes (depending on the type of concrete structure, class of working reinforcement and its position in the cross section of the structure). It has a low bulk density ( $450 \text{ kg/m}^3$ ), thanks to which it provides high values of fire resistance at significantly lower material costs. In addition, passive fire-retardant coatings manufactured by the same company are known: highly dispersed paint "OZK-01" and fire-retardant coatings "IZOVENT-PZh" and "IZOVENT-UP". According to the manufacturer, fire-retardant paint "OZK-01" is the simplest and high-tech way of fire protection of reinforced concrete. The paint is applied to the soil "GAZ-K" (0.05 mm thick) and at a dry layer thickness of 1.1 mm and a consumption of  $1.9 \text{ kg/m}^2$  has a fire-retardant efficiency of at least 120 minutes when reaching the limit state. "IZOVENT-PZh" coating is designed to increase the limit of fire resistance of reinforced concrete structures and is a composite slab with dimensions of  $1200 \times 600 \text{ mm}$ .

Another well-known manufacturer of passive fire-retardant coatings for reinforced concrete structures of JSC "A+B Baltika" (Kaliningrad, Russia) has developed a coating composition based on fire-retardant composition "Phoenix STV". Passive fire-retardant coating provides fire resistance of reinforced concrete building structures of buildings and structures for 150 minutes. Also known coating "Devisprey" to increase the fire resistance of building structures to 150 minutes. Passive fireproof coating "Devisprey" consists of kaolin fiber, inorganic binder (Portland cement) and special additives. This coating is a non-combustible thermal insulation system with low air permeability and high thermal protection properties, which allow to perfectly protect reinforced concrete building structures from the effects of heat flow and flame. The coating is used to protect steel, reinforced concrete building structures on all types of civil and industrial construction.

“Neospray” fire retardant coating consists of expanded vermiculite, inorganic binder, fillers and target additives. “Neospray” fire-retardant coating is a fire-retardant plaster that forms a non-combustible thermal insulation system with low air permeability and high heat-protective properties, which allow to protect building structures from the action of heat flow and flame for a specified time. Fire-retardant treatment with “Neospray” coating increases the limit of fire resistance of reinforced concrete building structures to 240 minutes. The disadvantage of all these passive fire-retardant coatings is the impossibility of use in open areas under the influence of climatic factors, the large thickness of the coating, expensive equipment for application.

“Technoterm Group” Ltd. manufactures high-performance fire-retardant composition “Soterm-1B”, designed for fire protection of reinforced concrete structures, operated both inside premises, buildings and structures for industrial and civil purposes, and outside them. The composition applied to reinforced concrete multi-hollow slabs provides a fire resistance limit (*REI*) of at least 180 minutes at a coating thickness of 25 mm. Fire tests were performed on samples that are full-size multi-hollow plates (6200×1150×220), loaded with a uniformly distributed load of 1115 kg/m<sup>2</sup>. The limit state was determined by the deflection of the central part of the plate. In both cases, the tests were stopped three hours after their start, until the values of deflections corresponding to the limit states were reached. “Soterm” formulations are mixtures of expanded vermiculite, inorganic binders, mineral micro-fittings and special additives, soluble in water in the conditions of the construction site with the formation of a paste. After applying the paste on the surface to be protected and drying, a fire-retardant coating identical to the composition of the original dry mixture is obtained.

For most fire-retardant coatings, the thermophysical characteristics are unknown, which complicates the establishment of fire resistance of fire-resistant building structures and evaluation of their effectiveness in the calculation and experimental determination of the limits of fire resistance of such structures.

Therefore, a detailed analysis and study of the properties of fire-retardant substances, in the future will scientifically substantiate the parameters of fire-retardant coatings for effective assessment of fire resistance of fire-retardant reinforced concrete building structures.

### 1.4.2 FIRE-RETARDANT MATERIALS USED FOR FIRE PROTECTION OF STEEL STRUCTURES

Statistics show that a large number of fires occur in buildings and structures made of steel structures. For example, the “DeepWaterHorizon” oil rig, which consists of steel structures, had a methane explosion and a fire that lasted 36 hours, after which it sank. 11 people died and 17 were injured. The accident was accompanied by prolonged (87 days) and large-scale (up to 4.9 million barrels) oil pollution in the Gulf of Mexico.

When designing the buildings of the World Trade Center, the impact strength was calculated (Boeing-707, weight 150 tons). Each tower withstood the impact of a Boeing-767, which weighed



about 30 tons more. The fire started from a fuel explosion in the tanks of the planes, which were 70 % full. The temperature of 1000–1200 °C caused rapid heating of the steel columns and crossbars, due to which they lost their strength and avalanche-like destruction of the towers occurred (103 and 62 minutes after impact, respectively).

All this indicates that steel structures are widely used in construction, but their use is accompanied by the need for fire protection to increase the fire resistance of such structures [99, 100].

In [99] the latest developments in the field of reactive fire-retardant coatings with special emphasis on organic coatings, which in their aesthetic appearance, speed of application, ease of maintenance has advantages over such types of fire-retardant coatings as concrete and plaster-board coatings. The role of different ingredients in the composition of the flame retardant, their interaction in coatings, the synergism of different pigments, binders and additives is briefly analyzed.

In the article [100] the results of experimental research of influence of a finishing covering on fire resistance of fire-retardant steel elements by reactive coverings, by comparison of temperatures and effective coefficients of thermal conductivity of coverings with a finishing covering and without it are presented. It is established that the effect of the finishing coating is enhanced by the use of thinner, swellable coatings. The topcoat affects the performance of water-based coatings under fire conditions in large rooms with a lower maximum temperature and a slower heating rate than standard fire conditions. At the same time, the issues of the influence of the coating thickness on the fire resistance of fire-resistant steel structures remained unresolved.

In [101], the temperature of a steel structure protected by a reactive fire-retardant coating during fire exposure was predicted using a constant value of the thermal conductivity. The results of the study of the possibility of using constant thermal conductivity for the swellable coating when calculating the temperature of a fire-resistant steel structure during a fire are presented. The research is based on the analysis of a series of tests for fire resistance of steel structures protected by a coating, with a series of coefficients of cross section and thickness of the reactive flame retardant coating. Constant thermal conductivity allows to develop simplified analytical equations for design. However, the constant value of the thermal conductivity is a rather rough approach to assessing the fire resistance of fire-resistant steel structures and does not always allow an accurate approach to the assessment of fire resistance.

In [102] the influence of flare hydrocarbon combustion on building structures and technological installations is considered. The results of tests of flame retardant reactive coatings on the developed experimental setup are presented, the criteria of the model of efficiency of flame retardant coatings are obtained: relative flame retardant efficiency, flare criterion. However, the issues concerning the defined criteria and their application in the estimated assessment of fire resistance of fire-resistant steel structures are not fully investigated.

In a fire, steel quickly loses its strength, which ultimately leads to a loss of load-bearing capacity until the destruction of buildings [103]. At temperatures above 400 °C for steels and over 200 °C for aluminium alloys, the creep of the material begins (significant development of plastic deformations under constant load). The high strength of the material causes relatively small

cross sections of structural elements. At the same time, steel has a high thermal conductivity, so in case of fire, the load-bearing structures made of steel and aluminium alloys are quickly heated to the temperature of transition of the metal to a plastic state and destruction occurs. Currently, the fire resistance of steel structures and their elements protected by fire-retardant coatings is normalized and determined by tests for fire resistance at standard fire temperatures, which does not always meet modern fire safety requirements for buildings and structures. For example, at the facilities of oil and gas and petrochemical complexes, fires are characterized by a rapid increase in temperature to 1100 °C at the beginning of its development [104, 105]. Therefore, the study of the behaviour of steel structures with fire-retardant coatings in test conditions at a fire temperature different from the standard is an important element of the system of reliability of buildings and structures by using fire-resistant steel structures with scientifically sound parameters of fire protection systems.

The main task of fire protection of steel structures is to create on their surface a heat-insulating layer with low thermal conductivity, which is able to withstand high temperatures and insulate the surface of the material from the direct action of dangerous fire factors [106].

The following methods are used for fire protection of steel structures:

- constructive-planning decisions and re-planning of premises taking into account fire-hazard technologies;
- facing with large elements;
- use of fire-retardant elements;
- concreting;
- plastering;
- facing with a brick;
- facing with ceramic tiles;
- increase the cross section of load-bearing elements.

The method of fire protection of the structure depends on the normalized limit of fire resistance, type of structure, operating conditions of the structure, aggressiveness of the environment.

Each of the methods of fire protection has its disadvantages and advantages.

The choice of constructive protection is made on the basis of technical and economic calculation. So, at concreting it is necessary to consider constructive properties of concrete and a design as a whole. Brick cladding has a negative effect on architectural planning decisions, reducing the useful volume. Applying plaster requires significant material costs. In addition to the chemical composition, the key determining factors in the use of fire-retardant coatings were the boundary conditions of the protected surface, the thickness of the coating, heating conditions and the method of testing for fire resistance. All of them should be considered for accurate and systematic testing and development of an environment that allows you to explicitly quantify the effectiveness of flame retardant coatings [107].

As practical experience shows, constructive measures in their effectiveness are not widely used due to the complexity, as well as the complexity of their implementation at the stage of

reconstruction in the re-profiling of production technology. The above facings are quite reliable and durable, but they significantly increase the weight of structures and are time consuming.

The desire to reduce the weight of fire-retardant cladding has led to the recent development of light plasters and coatings based on asbestos, perlite, vermiculite, phosphate compounds and other effective materials.

These facings have a low density (200–600 kg/m<sup>3</sup>) and therefore low thermal conductivity. They can be used to increase the fire resistance of structures up to 45 minutes or more.

Fire tests have shown that, for example, fire-retardant phosphate coating is able at a thickness of 25 mm to increase the fire resistance of the column of box section 200×200×16 mm to 120 minutes. Such a limit of fire resistance of facing from usual heavy concrete can be provided only at a thickness of 50 mm. Therefore, the use of phosphate coating instead of concrete reduces the mass of fire-retardant cladding by 10 times [108].

Fastening of light facings on a surface of designs is provided with reinforcing frameworks and anchors from a wire with a diameter of 3 mm.

For fire-retardant facing it is possible to use the semi-rigid mineral wool plates fastened by means of steel anchors and frameworks.

In recent years, various fire-retardant coatings, varnishes and paints are more widely used for fire protection of building steel structures [109, 110].

In [109], an experimental study of cracks and delamination of reactive flame retardant coatings and their effect on increasing the temperature of steel elements. As a result, it was found that cracks and delamination affect not only the average temperature of fire-retardant steel structures, but also the temperature distribution inside the fire-retardant steel structure. However, the effect of cracks and delamination of reactive flame retardant coatings as a result of climatic factors has not been studied.

In [110] the efficiency and influence of different flame retardant compounds on the characteristics of steel during a fire were studied. The formulations are based on fire-resistant additives, which include substances as binders and refractory fillers for the synthesis of water-based coatings.

To increase the fire resistance of load-bearing steel structures use 2 methods: insulation and heat dissipation. Thermal insulation is provided by applying plaster, cladding, application of substances that swell under the action of temperature.

[111] presents the results of an experimental study to investigate the effect of topcoat on the durability and fire-retardant properties of swellable coatings for steel structures. The results of chemical analysis tests show that the topcoat can limit the migration of hydrophilic components of the swellable coatings and, therefore, improve the shelf life of the coatings.

Therefore, other things being equal, the advantage remains for fire-retardant coatings with a greater limit of fire resistance [112].

In [112], the thermal characteristics of a new swellable flame retardant coating were studied in the laboratory using a combination of small-scale and large-scale tests. For small-scale tests, experiments were performed using thermogravimetric analysis at several heating rates in

a nitrogen atmosphere. The results showed that the thermal destruction of the coating occurred at different stages, and the main weight loss occurred at a temperature of about 300 °C. For large-scale tests, experiments were performed in a conical calorimeter using a stainless steel plate as a platform to support the sample. The results showed that the normal height of the expansion of the coating was constant at different levels of heat flux. Therefore, the expansion of the coating can be considered as a function only of the rate of mass loss, and not on the magnitude of the external heat flux.

In [113, 114] fire-retardant compositions are proposed, which can work in the conditions of both standard temperature regime and hydrocarbon fire regime, which is quite relevant for the objects of oil and gas industry.

In [114] the authors developed a new flame retardant for hydrocarbon fire conditions with improved rheological characteristics due to synthesized organ clays and studied the physicochemical patterns of coke layer formation at high temperatures other than the standard temperature curve. However, the researchers did not pay attention to the use of the developed coatings in other arbitrary fire regimes.

The heat-resistant material "Rubin", which swells, was developed at the Central Research Institute of Structural Materials "Prometheus" and the Central Design Bureau of Marine Technology "Rubin" (St. Petersburg, Russia). Ruby-based coating has high physical and mechanical properties: flexural elasticity – 20 mm, impact strength – 30 mm. The five-layer, 2 mm thick, swellable coating of fire-retardant material ensures fire resistance of the steel structure for 45 minutes. However, researchers do not provide data on the use of the developed composition in other arbitrary fire regimes with scientifically sound parameters.

Several fire-retardant coatings have been developed abroad, mainly on an organic basis [115–117].

[115] presents the characteristics of heat dissipation, charring and fire-retardant characteristics of swellable thin-film coatings. The fire-retardant ability of the coatings was evaluated using the Bunsen burner test to study the equilibrium temperature and the formation of a charred layer. As a result, it was found that the addition of biofiller is effective to limit the spread of fire, as well as to reduce the heat released after heat exposure and the equilibrium temperature of the coatings.

In [116], two series of new sol-gel coatings were prepared, which contained floating fly ash balls and granular blast furnace slag using Na<sub>2</sub>SiO<sub>3</sub> as an alkaline activator in combination with an organic modifier and a film-forming agent. The results showed that the geopolymer coating has turned into a layer to block heat transfer and mass, which reduces the value of heat dissipation rate and fire growth index, as well as to increase the fire resistance index.

In [117] for the first time an effective coating based on benzoxazine was developed. The proposed compositions were applied to steel structures and subjected to fire resistance tests. The coatings were characterized by thermogravimetric analysis and microcalorimetry. The developed composition, which forms a coating on the steel surface, showed effective protection against fire. Steel structures coated with flame retardants containing expanded graphite showed a decrease in temperature by 300 °C compared to the uncoated substrate.

---

“Tremco Illbruck Coatings Limited” – NULLIFIRE (UK) for fire protection of steel structures produces a reactive flame retardant with the trademark R-60. Preservation of appearance of a covering is provided by drawing a finishing layer of material Top Scaler. The thickness of the formed coating with a thickness of 1.5 mm provides the limit of fire resistance of the steel structure up to 60 minutes.

[118] presents the methodology and results of the study of the characteristics of the variability of the temperature dependence of the thermal conductivity, defined in EN 13381-8, and the dry film thickness for one type of reactive flame retardant coating in standard fire conditions, as well as their impact on coating reliability. structures.

The System – S60 fire retardant coating, developed by Nullifire Ltd, is a water-based reactive fire-retardant coating. With a coating thickness of up to 10 mm, the coating provides a limit of fire resistance of steel structure up to 90 minutes.

The well-known alkyd fire-retardant coating manufactured by Berger Industrial Coatings – Uniterhm provides an increase in fire resistance of steel structures from 30 to 60 minutes. Other reactive flame retardant coatings based on aminoformaldehyde copolymers using phosphogypsum and polyphosphates as gasifiers and flame retardants are also known. Such coatings are produced in Germany (DS-324, “Pyromors”) and Finland (“Winter”).

In Ukraine, certified flame retardants and polymer-based paints: “Poloplast-K” (Hungary), UN-UTERM 38091 (HERBERTS GmbH, Germany), “FOUM-COAT” (USA), “Biro-COAT” (Germany) and many others, which are used to increase the limits of fire resistance of steel and aluminium structures.

As can be seen from the analysis, there are a large number of fire-retardant substances and materials to increase the limits of fire resistance of steel structures. However, to date, the list of required parameters of the thermal state of fire-resistant load-bearing steel structures to ensure fire resistance of buildings and structures during their operation in high-temperature fire, and consequently, the loss of stability and serviceability of individual structures and buildings in general [119].

## CONCLUSIONS ON SECTION 1

1. Analysis of the current state of fire safety of buildings and structures of industrial and civil construction showed the presence of contradictions that arise in the process of analyzing the conditions for fire resistance of fire-retardant building structures. Resolving these contradictions creates the conditions for safe operation of buildings and structures using fire-retardant reinforced concrete and steel structures with scientifically sound parameters of their fire-retardant coatings. Based on the analysis, it is established that ensuring the normalized value of the limit of fire resistance of load-bearing elements of reinforced concrete and steel building structures is an important and complex problem, the solution of which will allow at the stage of design, construction and operation of buildings and structures of industrial and civil construction. construction of building

structures that are able to provide buildings or structures with resistance to high temperatures or destruction due to disruption of the normal cycle of operation of the object.

2. Analysis of emergencies and fires in the world showed that most fires occur in buildings and structures (51 %). For Ukraine, this figure for the last ten years is 52.7 % of the total number, and the number of deaths on them – 95.5 %. The main principles of fire resistance of structures are the use of active and passive means of increasing the fire resistance of steel and reinforced concrete structures. As a result of the analysis, it was found that a large number of emergencies, including fires, occur due to neglect or disregard in the design of requirements for fire resistance of building structures, including fireproof, which make up buildings and structures.

3. One of the priority areas to ensure fire resistance of buildings and structures is the use of fire-resistant building structures. Increasing the fire resistance of fire-retardant building structures is provided by the use of fire-retardant substances with scientifically sound parameters. An effective principle of increasing the fire resistance of fire-retardant building structures is the use of reactive and passive fire-retardant coatings for fire protection of steel and reinforced concrete structures, which increase the limit of fire resistance of such structures to normalized values. An analysis was performed, as a result of which it was established that there is a large number of fire-retardant substances and materials to increase the limits of fire resistance of steel and reinforced concrete structures. However, to date, the list of necessary parameters of the thermal state of fire-resistant load-bearing steel and reinforced concrete structures to ensure fire resistance of buildings and structures during their operation in high-temperature fire, and therefore, the loss of stability and serviceability of both individual structures and the building as a whole.

4. Fire-retardant coatings are represented by a wide range of both domestic and foreign production, the analysis of the characteristics of which requires detailed study. Given the above, the definition of effective tools, technologies and methods for calculating the fire resistance of building structures and the parameters of fire protection of building structures in general is quite relevant. Therefore, a detailed analysis of the composition and properties of fire-retardant substances, which will further provide a scientific basis for the parameters of fire-retardant coatings to determine the fire resistance of fire-retardant reinforced concrete structures, is an insufficiently studied problem.

**ABSTRACT**

---

The analysis of experimental and calculation methods of fire resistance assessment of unprotected and fire-protected steel and reinforced concrete building structures is carried out. Their advantages and disadvantages are described. The conducted analysis allows to state the tendency of spreading the application of the calculation-experimental method for estimating the limits of fire resistance of fire-retardant reinforced concrete and steel building structures and fire-retardant ability of coatings for such structures. The conclusion is made, which consists in the need to develop computational and experimental methods for assessing the fire resistance of fire-resistant steel and reinforced concrete building structures. The methods must have sufficient accuracy for engineering calculations when estimating the limits of fire resistance of fire-retardant structures with fire-retardant coatings.

**KEYWORDS**

---

Experimental method of fire resistance assessment, calculation method of fire resistance assessment, climatic factors, calculation-experimental method of fire resistance assessment.

**2.1 METHODS FOR ASSESSING THE FIRE RESISTANCE OF BUILDING STRUCTURES****2.1.1 EXPERIMENTAL METHODS**

Determining the limits of fire resistance of building structures, both with and without fire protection, can be performed both by calculation methods (simplified method, refined method, determination of fire resistance using tabular data) and based on experimental tests for fire resistance.

Recently, considerable work has been done in Ukraine on the standardization of methods for determining fire resistance for almost all types of building structures. Thus, the requirements for methods of testing building structures for fire resistance are set by the state standard DSTU B V.1.1-4-98\*. It considers the main provisions of current regulations, requirements and recommendations of the International Standard ISO 834-1:1999, the European Standard EN 1363-1. A significant step forward was the adoption of a number of national standards for test methods for building structures and products for fire resistance. DSTU B V.1.1-13:2007, DSTU B V.1.1-14:2007, DSTU B V-1.1-15.2007 and DSTU B V.1.1-20:2008 provide test methods

for fire resistance of beams, columns, partitions and floors in accordance. DSTU B V.1.1-19:2007 provides a method for determining the fire resistance of load-bearing walls. DSTU B V.1.1-17:2007 describes a method for determining the fire-retardant ability of fire-retardant coatings of metal structures. These standards, with some amendments and adaptation requirements, are in line with European standards EN 1365 and ENV 13381-4:2002.

The essence of the experimental method is to determine the period of time from the beginning of the impact of fire hazards to the onset of one of the normalized for a particular design of the limit states of fire resistance. The main principle on which the experimental method is based is the creation in a special test furnace of test conditions that are close to the real conditions of a fire in a room, building or structure [45].

European countries are guided by common (almost identical) standards for determining the limit of fire resistance of building structures, but in some cases, test methods are used that differ significantly from each other. At the same time, as practice shows, the limits of fire resistance of fire-retardant steel structures with the most famous fire-retardant coatings "Protherm Steel" (Italvis Protect Srl, Italy), "Nullifire" (Nullifire Limited, Great Britain) were studied in testing laboratories of different countries (Great Britain, Australia, Finland, Finland, Czech Republic, Bulgaria), regardless of the standards differ within the permissible range of deviations. In Europe, the concept of bringing all national standards to a single European standard EN 1363-1 is currently being implemented. This is confirmed by the appearance of new standards BS EN 1363-1 (UK), DIN EN 1363-1 (Germany), AF EN 1363-1 (France), which are technically equivalent in determining the performance of fire-retardant performance of fire protection. This approach greatly simplifies the promotion of imported products, the certification procedure in the consumer country, makes it more transparent and reliable, and also promotes the practice of recognizing the conformity of goods.

In Ukraine, there is a positive experience in the use of test methods according to DSTU B V.1.1-17:2007 – analogue of the European standard ENV 13381-4:2002 [120].

Experimental methods in determining the limits of fire resistance of reinforced concrete structures were used in [121–124].

[121] presents an experimental rapid assessment of the residual strength of reinforced concrete frame buildings after a fire based on non-destructive testing, which allows you to make a quick and reliable decision, which is necessary for rescuers, forensic experts and structural assessment of the building after fire. The disadvantage of the express method is the impossibility of its application for individual building structures.

In [122] the main attention of researchers was paid to the study of fire resistance of concrete columns in the conditions of tests at the standard temperature of the fire. Subsequently, the residual compressive strength of such columns was evaluated after exposure to a standard fire for 60 and 120 minutes and under load with two different load factors (20 % and 40 % of the calculated axial load of the column). As a result of tests, it was found that the columns never regain their original strength after exposure to the standard temperature of the fire. The residual



compressive strength of the column decreased to almost 50 % and 30 % of the allowable ambient temperature for columns exposed to 60 and 120 minutes of fire.

In [123] the results of experimental determination of the limit of fire resistance of a reinforced concrete beam at the standard temperature of the fire are given. According to the results of experimental studies, it is proposed to use the method of equivalent time to simulate a real fire using the test results of the beam at the standard temperature of the fire. However, the researchers did not pay attention to the use of the method for other building structures and fire regimes.

In [124] the destruction of reinforced concrete columns after exposure to high temperatures at different temperatures of the fire was analyzed. It is concluded that when assessing the reliability of a reinforced concrete column it is necessary to consider the real temperature of the fire.

An experimental method for determining the limits of fire resistance of fire-resistant and un-protected steel structures was described in [125–127].

In [125] experimental and calculated data on determination of temperature of steel plates with a fire-retardant covering in the conditions of fire influence on a standard fire mode are resulted. The authors analyze the possibility of using samples of reduced size and shape other than the size and shape of standardized samples of steel structures to assess the fire resistance of fire-resistant steel structures.

[126] considers the results of experimental tests of steel plates of different sizes with water-based flame retardant coating, aimed at studying the thermal properties and the ratio of temperature and thickness of the coating in tests of steel plates of different thickness at standard temperature or fire mode, which is slow developing.

[127] describes experimental studies of the behaviour at elevated temperatures of unprotected and fire-retardant steel beams having different sizes and shapes of holes. Experiments have shown that the results of tests for fire resistance of fire-retardant steel beams were contradictory in terms of their behaviour at elevated temperatures, the type of material of the fire-retardant coating and its minimum thickness. Thus, experimental methods for assessing the fire resistance of fire-resistant steel and reinforced concrete structures are the most accurate. However, along with the advantages, such methods have disadvantages, which are manifested in the complexity of sample production, preparation, delivery and testing of fire resistance of large building structures. This causes significant material costs for testing in accredited laboratories, makes it impossible to transfer the test results to structures of all sizes and types. The above shortcomings create significant limitations in the use of experimental methods for assessing the fire resistance of fire-resistant steel and reinforced concrete structures.

## 2.1.2 CALCULATION METHODS

One of the most common methods for determining the fire resistance of building structures is the use of Eurocodes and harmonized with them national standards of Ukraine. One of the priorities

of European policy is the gradual approximation of Ukrainian legislation, norms and standards to the relevant documents of the European Union. The development of the regulatory framework in Ukraine is carried out using the experience of the European Union (regarding the harmonization of Ukrainian legislation in the field of construction and the regulatory framework regarding the design of building structures, standards for construction products).

At present, Ukraine has developed and approved national standards for reinforced concrete and steel structures, harmonized with Eurocodes, namely:

- DSTU-N B V.1.2-13:2008 Reliability system and safety in construction. Attitude. Fundamentals of structural design (EN 1990:2002, IDT);
- DSTU-N B EN 1991-1-2:2010 Eurocode 1. Actions on structures. Part 1–2. General actions. Actions on structures during fire (EN 1991-1-2:2002, IDT);
- DSTU-N B EN 1992-1-2:2012 Eurocode 2. Design of reinforced concrete structures. Part 1–2. Terms. Calculation of structures for fire resistance (EN 1992-1-2:2004, IDT);
- DSTU-N B EN 1993-1-2:2010 Eurocode 3. Design of steel structures. Part 1–2. Terms. Calculation of structures for fire resistance (EN 1993-1-2:2005, IDT);
- DSTU-N B EN 1990:2008 Eurocode. Fundamentals of structural design (EN 1990:2002, IDT).

During the development of Eurocodes, it was assumed that the demonstration of compliance with regulatory requirements for alternative methods should be carried out using calculations based on the performance of materials and structural elements.

In the general case, the calculation of building structures for fire resistance includes thermal and static parts. The thermal part consists in the calculation of temperature fields in the cross section of the structure, which change over time under the thermal influence of fire [128–132].

In [128] the results of values calculation of time of achievement of critical temperature for samples of steel designs which have various values of the resulted thickness of a steel profile and thickness of fire-retardant coverings in the conditions of fire influence on standard temperature of fire are presented. It is established that experiments on samples of reduced size should be performed using steel plates with two thicknesses (minimum 5 mm and maximum 10 mm), and a layer of fire-retardant coating on them, which has three values of thickness: minimum, average and maximum.

In [129] the results of determining by calculation methods of uniform and non-uniform temperature distributions along the cross section of the steel beam on which the concrete slab rests, for fire exposure to the standard temperature of fire unprotected steel beam and steel beam on the surface of which is applied fire-retardant substance are presented. Calculations of the temperature of the steel beam with its uniform distribution were performed using the computer program FRIEND, and calculations of non-uniform temperature distributions in the cross section of the steel beam were performed using the program ANSYS FLUENT. ANSYS FLUENT allows to model processes of heat exchange in three-dimensional statement with the best, in comparison with FRIEND, visualization. However, the ANSYS FLUENT program, unlike FRIEND, has a longer time to calculate the temperature distribution in the structure.

In [130] the modelling of research of thermal properties of reinforced concrete structural elements is carried out. Thermal analysis was performed numerically using the ABAQUS package. The results of the research are compared taking into account the influence of boundary conditions, i.e., temperature, convection and radiation. Setting convective and radiation boundary conditions made it possible to obtain more accurate results. A reduction in the discrepancy between the calculated and experimental results was observed when using thermal characteristics according to the wording in Eurocode2, which considers the emission of moisture.

In [131] a model was developed to estimate the probability of loss of load-bearing capacity of a building structure as a result of a fire. However, the developed model does not answer the question of its use in arbitrary fire conditions.

In [132] the most important conclusions from the research conducted in this industry in recent years are described, the method of calculation of bearing capacity of steel columns considering uneven temperature heating in an element is formulated.

In [133], fires were studied by CFD analysis using Reynolds averages Navier-Stokes equations in combination with a turbulence model. The obtained temperatures were correlated with the experimental results obtained by infrared thermography.

The static part of the calculation of fire resistance is to determine the kinetics of loss of structures of its bearing capacity due to changes in mechanical properties and combustion of materials, as well as due to the development of additional efforts with increasing temperature [134–139].

In [134] the analysis of requirements of standards to carrying out tests on fire resistance of building designs of Ukraine, Belarus and the European Union is carried out. The comparison of fire resistance test results of the most common reinforced concrete multi-hollow slabs with the calculation data is carried out.

[135] presents the results of theoretical calculations of a freely supported steel beam exposed to the standard temperature of the fire using the developed model created in the ANSYS software package and in the OpenSEES software. At the same time, data on calculations with fire protection are not provided.

In [136] a method for estimating the fire resistance of a reinforced concrete floor slab was proposed. The methodology of application of methods of calculation of limits of fire resistance based on use of a method of finite differences, on an example of an estimation of fire resistance of a reinforced concrete plate of overlapping is developed. Requirements to the database of initial data on materials, boundary conditions, construction of calculation schemes and grid models, as well as a criterion base on the identification of the occurrence of boundary conditions have been developed. However, this technique is used only for reinforced concrete floor slabs and only for the standard temperature of the fire.

In [137] a method of approximation of the temperature field in the cross section of a reinforced concrete crossbar or beam was developed. An algorithm for determining the temperature at the nodal points of the section by interpolating the temperatures according to the temperature values at the control points of the section is proposed. This algorithm is based on the approxima-

tion of isotherm lines by elliptic and parabolic approximation dependences. However, the proposed technique is not applicable to fire-retardant reinforced concrete crossbars and beams and is used only for the standard temperature of the fire.

In [138] the results of development of methods of verification of results of calculation of limits of fire resistance of reinforced concrete designs by the specified methods based on modelling of their stress-strain condition in the conditions of fire are resulted. However, the work does not consider the thermal calculation of reinforced concrete structures.

In [139], an analysis of the destruction of a reinforced concrete bridge due to fire was performed using computational hydrodynamics and finite element models. The paper presents numerous models for predicting the limit of fire resistance of reinforced concrete structures of the bridge due to fire and provides recommendations for modelling thermal processes aimed at improving the structure of the bridge.

In [140], the authors developed two models of steel beams using ANSYS and OpenSEES programs, which take into account the constant mechanical load and the influence of fire temperature, but do not take into account the presence of fire protection systems and their impact on modelling accuracy.

The authors in [101] propose to use in the calculation of the temperature of fire-resistant steel structures in case of fire a constant value of the thermal conductivity of the reactive fire-retardant coating, as it does not affect the accuracy of the calculations. However, as is known, the greatest accuracy of calculations is at the value of the thermal conductivity of the fire-retardant coating, which depends on the temperature.

In [141] the results of the test for fire resistance of unprotected steel beams in comparison with simple and advanced calculation methods given in EN 1993-1-2 are presented. The results showed the difference between the experimental and calculated temperature values obtained by FEM analysis.

The development of methods for calculating the fire resistance of structures, especially in terms of solving the thermal problem, has become possible through the use of modern computer equipment.

When calculating steel structures for fire resistance, the following assumptions are introduced: the mechanical properties of steels are determined only by their temperature and do not depend on the mode of heating, loading and deformation; due to the high thermal conductivity of steel, the temperature is distributed evenly across the intersection of structural elements; the diagram of deformation of steels at high temperatures is similar to the diagram of deformation at normal temperature. It follows that the limit of fire resistance of steel structures is determined by the time of their heating to a temperature that corresponds to a decrease in load-bearing capacity to the level of fire loads. This temperature is called critical. For approximate calculations of elements of metal constructions at normative loading the temperature of 500 °C for steel elements and 250 °C for elements from aluminium alloys is accepted as critical. At loads other than standard, the value of the critical temperature of steel can vary from 350 to 750 °C. Such values should be specified by static calculation, which is based on the usual methods of static calculation of steel

structures, considering changes in the properties of steel. The scope of research on changing the properties of steel structures under the influence of temperatures corresponding to fire conditions is quite limited.

Thus, the use of calculation methods for assessing the fire resistance of unprotected and fire-resistant steel and reinforced concrete building structures, compared to experimental, has a number of advantages, such as the ability to perform calculations without high material costs, although certified software products that are expensive and high quality specialists who will be able to correctly and reasonably set the parameters of the model of the thermal state of fire-resistant building structures. After all, inaccuracies in setting the initial, boundary conditions and inaccuracies in the use of mathematical and physical models of thermal processes occurring in fire-retardant structures under fire, can lead to erroneous assessment of fire resistance of fire-resistant building structures, and thus to miscalculations in the design of buildings and structures of such constructions.

### 2.1.3 CALCULATION AND EXPERIMENTAL METHODS

Computational and experimental methods occupy a certain place among the main methods of the research (analysis) of reinforced concrete and steel building structures for fire resistance (**Fig. 2.1**). The basis of the methods is a mathematical (computational, computer) model of the physical process, and the experiment (experimental data) is an auxiliary component necessary to ensure the adequacy of the selected process model.

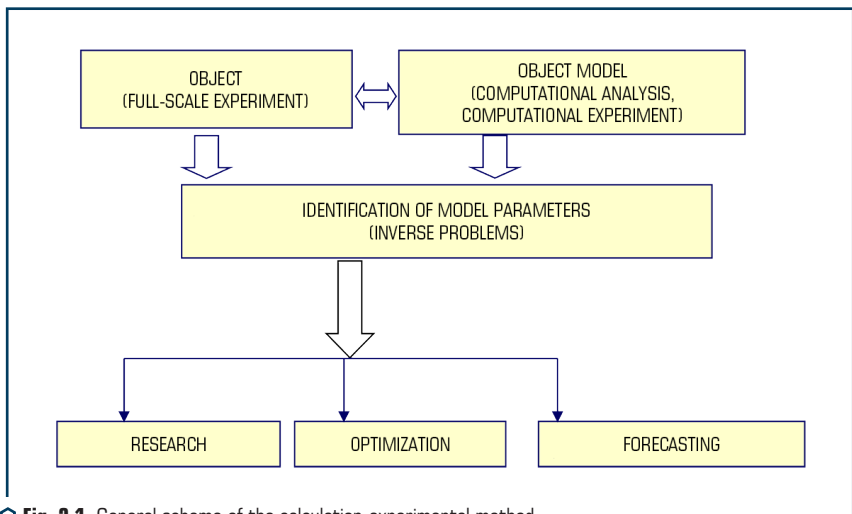

Fig. 2.1 General scheme of the calculation-experimental method

Computational and experimental methods are a method of analysis, optimization and prediction of heat and mass transfer processes, based on a computer or computational model, the adequacy of which is ensured by parametric or structural identification with experimental information about the process and solving inverse thermal conductivity problems. Thus, in accordance with the above definition, the main components of the calculation and experimental method (**Fig. 2.1**) are:

1. Mathematical or numerical model of the physical process.
2. Experimental data needed to ensure the adequacy of the process model.
3. Methods of identification of parameters of the chosen process model in order to ensure its adequacy.
4. An adequate mathematical model is obtained, which is then used to solve the tasks of analysis, optimization or prediction of the physical process under study.

The object and the mathematical model, which describes the basic physical processes occurring in the object, allow to obtain, respectively, the experimental characteristic ( $T_E$ ) and calculate the model characteristic ( $T_M$ ). In turn, these characteristics depend on a number of input parameters  $P$  of physical or technological nature.

In our case, such parameters include thermophysical characteristics of steel and fire-retardant coating – thermal conductivity and specific heat. The parameters  $P$  are usually unknown, and their determination is possible by solving the inverse problems of thermal conductivity according to experimental measurements of  $T_E$ . The solution of the inverse problems of thermal conductivity is reduced to the search for such values of  $P$  for which the calculated ( $T_M$ ) and experimental ( $T_E$ ) values of some characteristics (in our case thermal) become close to each other.

The criterion for the proximity of these characteristics is most often the value

$$F(P) = \sqrt{\frac{\sum_{j=1}^m (T_{M,j} - T_{E,j})^2}{m}} \approx \delta, \quad (2.1)$$

where  $m$  – the number of experimental measurements used to solve the inverse problem;  $\delta$  – root mean square measurement error.

The parameters of  $P$ , the process under study, obtained by solving inverse problems, are used on the basis of the same model to solve the main engineering problems of analysis – parameter optimization or forecast. In our case – to obtain the characteristics of the fire-retardant ability of the coating. Solving inverse problems is an auxiliary procedure aimed at ensuring the adequacy of the chosen model to the physical processes under consideration.

Thus, the scheme of the calculation-experimental method consists of the following stages:

1. Construction of physical and selection of  $P$  mathematical models of the thermal state of the building structures under test.
2. Carrying out of tests (experiments) which are reduced to measurement of temperatures on a surface of the constructions under test, and in the fire furnace.

3. Identification of experimental thermophysical characteristics of the model based on the solution of inverse problems of thermal conductivity.

4. The use of thermophysical characteristics and models to determine the characteristics of the fire-retardant ability of coatings of steel and reinforced concrete building structures according to the results of fire resistance tests.

The above approach can be defined as a set of methodology, models, equipment, methods and techniques and as a way (means) to achieve the goal.

Determination of the limit of fire resistance in the additional (alternative) mode of fire is carried out if it is defined in the regulatory or design documentation for the structure.

Combined computational and experimental methods are more powerful and accurate methods compared to separate experimental or computational methods. As can be seen from the analysis, the calculation-experimental method has an experimental and calculation part. Experimental includes testing for fire resistance. Computational includes the choice of mathematical and computer models of physical processes occurring in the studied objects, the choice of procedures for determining the parameters of the model by solving inverse problems and determining the characteristics of fire-retardant coatings of building structures by solving a number of direct problems.

## 2.2 TEST EQUIPMENT FOR THE STUDY OF FIRE RESISTANCE OF REINFORCED CONCRETE AND STEEL BUILDING STRUCTURES

The test equipment includes:

- test furnaces;
- equipment for installing the sample in the furnace;
- measuring equipment;
- equipment that allows you to take photos and videos.

The test furnaces must create the temperature and excess pressure in the furnace and provide conditions for the attachment, support and loading of the specimen in the furnace.

The design of furnaces must provide the possibility of heating walls, partitions, coatings, ceilings, windows, doors on one side and beams, columns, upright and other rod structures on three or four sides. The dimensions of the furnaces must be such as to enable tests to be carried out on samples the dimensions of which correspond to the design dimensions of the building structures.

According to the method of heating the working medium, test furnaces are divided into fire and electric. In fire furnaces, the required temperature is created by burning liquid (diesel, kerosene) or gaseous fuel (methane, propane, acetylene) in burners.

A manual or automatic temperature control system is used to create the temperature regime in the furnace.

Full-size test furnaces are designed primarily for certification testing of building structures in order to determine their actual limit of fire resistance and other indicators of fire hazard. Depend-

ing on the position of the building structure during the test, furnaces are divided into horizontal, vertical, special and universal (adjustable).

Vertical test furnaces are used to test walls, partitions, structures with glazing, which are made of concrete, reinforced concrete, brick, as well as multilayer structures containing layers of metal, plasterboard, wood, expanded polystyrene, doors, gates, windows for fire resistance (**Fig. 2.2**).

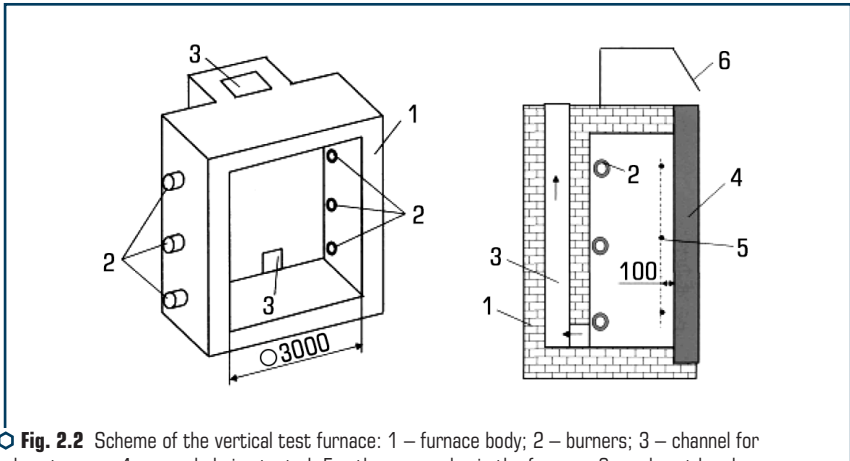

○ **Fig. 2.2** Scheme of the vertical test furnace: 1 – furnace body; 2 – burners; 3 – channel for exhaust gases; 4 – sample being tested; 5 – thermocouples in the furnace; 6 – exhaust hood

Horizontal test furnaces are used to test slab and beam horizontal structures for fire resistance. With the help of these furnaces, they test slabs and floors, beams, stairs, suspended ceilings (**Fig. 2.3**).

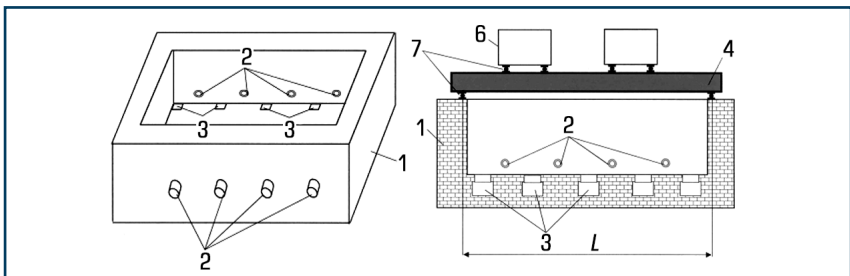

○ **Fig. 2.3** Scheme of the horizontal furnace: 1 – furnace body; 2 – burners; 3 – channels for exhaust gases; 4 – sample being tested; 5 – thermocouples in the furnace; 6 – load on the sample; 7 – hinged supports



Special test furnaces are used for thermophysical testing of materials and determination of the limit of fire resistance of fragments of structures and products in case of fire. In these furnaces fragments of columns, fragments of garbage pipes and cables are tested (**Fig. 2.4**).



**Fig. 2.4** General view of special test furnaces: *a* – LLC "Test"; *b* – LLC "Donstroytest"

Universal (adjustable) test furnaces are used to test a variety of building structures: horizontal, vertical and inclined.

Laboratory furnaces are used for testing small (reduced) samples of building structures or fire-retardant materials in order to determine their thermophysical characteristics, forecast the limit of fire resistance of real structures, comparative characteristics of different materials, quality control of products and exploratory experimental studies of building and fire-retardant materials [35].

Measuring equipment required during the tests includes:

- systems for measuring the temperature in the furnace, as well as on the sample;
- devices for measuring excess pressure in the furnace;
- devices for measuring the load on the sample;
- devices for measuring deformations of the sample;
- devices for assessing the integrity of the sample.

The use of other means for measuring ambient temperature is permitted, if they ensure the accuracy of the measurement.

If the sample is loaded by gravity method, it is not necessary to control the amount of load during the test.

Measurement of deformations of the sample can be performed by mechanical, optical or electrical devices.

To assess the integrity, you must use two types of devices:

- device based on a cotton swab;
- probes of two standard sizes.

The device based on a cotton swab consists of a cotton swab and a wire frame with a handle with a holder.

Analysis of furnaces for natural fire tests of building structures showed that:

- the use of furnaces for natural tests is preferable due to the fact that they allow to take into account all the features of the studied element and the conditions that occur during a fire;
- a large number of varieties and sizes of furnaces due to their imperfection and the ability to test only samples of certain designs and sizes;
- testing on these furnaces is very time consuming and high cost, also requires special conditions, large areas and leads to environmental pollution;
- in some cases, existing furnaces cannot provide field tests due to the fact that the structures are very complex and cumbersome;
- testing of building structures in full-scale furnaces is carried out in the conditions of the standard temperature regime of the fire, which does not consider the peculiarities of real fires.

### 2.3 ANALYSIS OF THE CONDITIONS FOR CONDUCTING RESEARCH ON REINFORCED CONCRETE AND STEEL BUILDING STRUCTURES FOR FIRE RESISTANCE

In [142], the mechanisms of load transfer of a composite reinforced concrete floor in case of failure of joints due to axial stretching, vertical shear and bending were investigated. Based on the obtained results, some design recommendations for increasing the fire resistance of building structures are proposed. Two models developed by the authors are used to model the behaviour of final and partial joints of composite structures in a fire. However, the authors have not studied other types of reinforced concrete structures and temperature regimes other than the standard.

In [143] using the concept of artificial neural networks and the results of numerical analysis as input parameters, a forecasting model was built to determine the limit of fire resistance of reinforced concrete columns built into the walls at standard fire temperatures. This article provides a brief description of the numerical analysis of columns exposed to fire according to ISO 834, conducted by the computer program FIRE. At the same time, the questions concerning the application of the developed model for forecasting the limits of fire resistance of other reinforced concrete structures for arbitrary fire regimes remained unresolved.

During the procedure of determining the minimum sample sizes, the dimensions of a typical room of 3×3 m and a height of 3 m are taken as a basis. During the development of the test sample, it is necessary to consider the design features and the scheme of its operation [144].

In [144] the state and prospects of the research of fire resistance of reinforced concrete columns are analyzed. A comprehensive analysis of the ultimate bearing capacity and mechanical behaviour of the columns during and after exposure to high temperatures. Statistical analysis was performed to identify various influencing factors, including temperature, method of fire exposure, cross-sectional area and shape, concrete strength and physical state, axial load factor and load ec-

centricity, longitudinal reinforcement, flexibility and conditions of column edge fixing. However, the paper does not consider the study of fire resistance of fire-retardant reinforced concrete columns.

It is important to provide for the presence in the structure of joints between the parts of the structure under test, as well as with other structures.

Thus, a variety of equipment and devices are used to conduct fire resistance tests, which must have a certain accuracy, be metrologically verified, and fire furnaces must be certified in order for the test results to be considered to meet the requirements of current regulations.

### 2.3.1 ESTIMATED TEMPERATURE SCENARIOS FOR THE STUDY OF REINFORCED CONCRETE AND STEEL BUILDING STRUCTURES FOR FIRE RESISTANCE

One of the main criteria for calculating the fire resistance of any building structure is to determine the temperature and time dependence of the fire, which should apply only to one fire compartment of the building, unless otherwise specified in the project scenario of fire development. There are nominal and parametric temperature regimes.

Nominal temperature regimes are used in the national design standards for the design of steel structures. Methods of modelling a real (calculated, parametric) fire can be used in the development of measures for fire protection of buildings and structures.

Nominal temperature-time dependences are generally accepted modes of fire development, which are adapted for the reproducibility of such studies, classification and confirmation of fire resistance of various building materials, products and structures.

In [145] the following nominal temperature regimes are established: standard temperature regime of fire development, temperature regime of external fire and hydrocarbon fire regime (HCF).

The generally accepted nominal modes of fire development also include temperature regime of a slowly developing fire, modified temperature-time dependence of hydrocarbon fire development (HCD), fire development modes in tunnels (dependence curves RWS, RABT ZTV, etc.). The curves of dependence of some nominal modes of fire development are presented in **Fig. 2.5**.

Standard fire – temperature-time dependence, defined in ISO 834, to represent the scenario of a fully developed fire in the fire compartment. The standard temperature regime is an average dependence and corresponds to the development of fire in residential and public buildings. It is assumed that the fire load is equivalent to 50 kg/m<sup>2</sup> of wood. This temperature regime is sometimes called the “cellulose curve”.

$$T = 345 \cdot \lg(8t + 1) + T_0, \quad (2.2)$$

where  $T$  – the temperature in the furnace corresponds to the time  $t$ , °C;  $T_0$  – the temperature in the furnace before the onset of heat (taken equal to the ambient temperature), °C;  $t$  – time calculated from the beginning of the test, min.

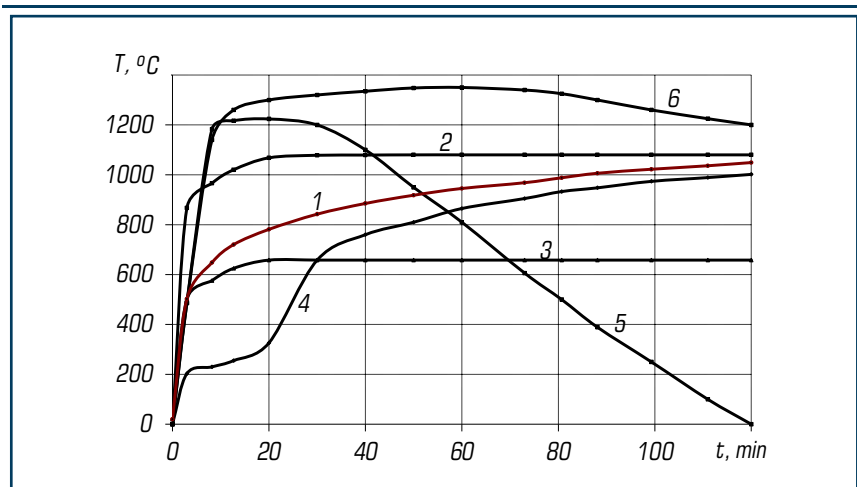

○ **Fig. 2.5** Dependence of temperature change on the duration of fire exposure at different heating rates: 1 – standard temperature curve according to ISO 834 and GOST 30247.0-94; 2 – hydrocarbon curve according to EN 1363-2:1999; 3 – minimized a single standard temperature curve according to ISO 834; 4 – external fire curve according to EN 1363-2:1999; 5 – tunnel curve according to German standards (RABT); 6 – tunnel curve according to the standards of the Netherlands (RWS)

However, today tests to determine the limit of fire resistance of structures can be carried out at standardized temperature regimes, which simulate the stage of a developed fire in other scenarios of conditional fire. These regimes are defined according to the same principles as the “standard” temperature regime and are regulated by the relevant standards [146]. Such modes are called “additional and alternative” standard temperature modes. The introduction of additional standardized temperature regimes allows to expand the possibilities of assessing the behavior of building structures in conditions that are close to the real conditions of the fire.

Combustion of various hydrocarbon fuels (flammable and combustible) is characterized by a rapid rise in temperature to 1100 °C. Such fires are possible at oil and gas and petrochemical complexes. In this case, to assess the fire resistance of building structures used “hydrocarbon curve” [147–151], which is characterized by the dependence:

$$T = 1080(1 - 0,325 \cdot e^{-0,167t} - 0,675 \cdot e^{-2,5t}) + 20. \quad (2.3)$$

In [147] the results of tests for fire resistance of fire-retardant steel structures using a fire-retardant coating based on acrylic resin with a typical combination of additives, namely: ammonium polyphosphate, pentaerythritol and expandable graphite. One of the main results of this work is the conclusion that higher values of heat transfer rate and more material involved in the

pyrolysis process per unit time, lead to a rapid increase in temperature of the steel structure. This information is useful in the design and development of fire-retardant coatings.

The aim of [148] is to develop a procedure for quantifying the structural criteria needed to manage the risks of catastrophic structural damage due effectively and efficiently to explosions and fires at offshore oil and gas facilities. The paper demonstrates the application of the developed procedure with an emphasis on the determination of explosive and fire design loads. However, the paper does not provide data on the assessment of fire resistance of fire-retardant steel structures of offshore oil and gas facilities in arbitrary fire conditions.

[149] describes the combined effect on the steel column of the explosion, which causes deformation and subsequent fire in assessing the risks of explosion of hydrocarbons and fires at sea installations. However, the authors do not take into account the impact of fire protection on the assessment of the risks of explosions and fires at offshore installations.

In [104] the technical documentation for the design of building structures of the oil and gas complex at a special load – fire in the hydrocarbon models considered. A detailed review of international, European and American standards for determining the limits of fire resistance in modelling the combustion of hydrocarbons is presented. It should be emphasized that the requirements for the limits of fire resistance in a hydrocarbon fire for some buildings and structures are absent, so testing of building structures without proper calculations is unnecessary and economically impractical. Development of branch standards for the enterprises of oil and gas branch with the list of parameters of a fire-retardant covering for protection of building designs in the conditions of a hydrocarbon fire is offered.

The authors [105] present the results of the research to assess the risk of hydrocarbon fire and subsequent explosion, which can lead to serious damage to building structures, up to the destruction of the structure as a whole. Fire and heat simulation (FAHTS) and static load using ultimate strength were used in the thermal analysis. However, the authors ignored the issue of assessing the fire resistance of fire-retardant structures of the offshore platform.

In [133], hydrocarbon reactive fires were modelled using CFD analysis using the Reynolds equation in combination with the turbulence model. The resulting temperature values showed satisfactory agreement with the experimental results obtained using infrared thermography. The values of the total heat flux were also analyzed, which indicates some limitations of the model.

[150] developed a technique for modelling hydrocarbon explosions and fires using computational hydrodynamics (CFD). The results of the study are part of the phase of a joint sectoral project on explosion protection in floating systems of oil production, storage and unloading.

In [151], mathematical models were developed using computational hydrodynamics (CFD) methods to predict the behaviour of hydrocarbon deposits.

Thus, different approaches have been developed with different assumptions and simplifications and considering the relevant phenomena. However, the deviations in the forecasts of experimentally determined parameters, such as temperature profiles, flame height and radiant heat flux, implemented by the models are still high.

Therefore, the implementation of these models for predicting combustion phenomena and flame behaviour for different scenarios is limited.

The hydrocarbon temperature regime is more stringent than the standard fire regime. This mode should be used to determine the limits of fire resistance of building structures used in the oil industry, the combustion temperature of which increases much faster and is more important than the combustion of any other building and cladding materials.

Another possible type of burning is a fire in a tunnel. Under these conditions, when heat dissipation from the cell is complicated, an intense temperature regime is created – a “tunnel curve”. The temperature of the fire can reach 1200 °C and above, after 5–10 minutes.

In Europe, for the simulation of fires in tunnel structures, temperature regimes are used that differ from the standard temperature regime used to determine the fire resistance of structures of ordinary buildings and structures. These temperature regimes are characterized by a faster rise in temperature, as well as the presence of a temperature drop. Given the large size, complex structure and spatial shape of the structures of underground structures of this type, the experimental determination of their actual limits of fire resistance is associated with unreasonably high costs.

The “tunnel curve” is based on the scenario of fire development when burning cars. Thus, in Germany, the tunnel requirements were initially contained in the Guidelines for the Construction and Operation of Automobile Tunnels (RABT), then the temperature regime for the tunnels was included in the ZVT Tunnel [153].

In the Netherlands, the RWS temperature curve is used to assess the thermal and mechanical properties of fire-retardant coatings in tunnels in which the transport of dangerous goods is permitted. This curve is characterized by a rapid increase in temperature to 1200 °C in the first minutes and its subsequent slower increase to 1350 °C.

The temperature of the external fire creates less stringent conditions than when tested at standard temperature. This temperature-time dependence is used in determining the limit of fire resistance of the outer walls of buildings.

The temperature of an external fire is determined by the formula:

$$\theta_g = 660 \cdot (1 - 0,687e^{-0,32t} - 0,313e^{-3,8t}) + 20, \quad (2.4)$$

where  $\theta_g$  – ambient gas temperature in the fire compartment, °C;  $t$  – fire development time, min.

Currently, fire resistance of protected reinforced concrete and steel structures and their elements is normalized and determined in accordance with the standard temperature of the fire, which does not always meet modern fire safety requirements for the protection of buildings and structures.

The behaviour of such structures protected by fire-retardant coatings during their tests in other temperature conditions has so far been insufficiently studied. There are cases when at low heating rates reactive coatings are not completely swollen, and thus do not perform their function.

---

Existing methods do not allow to determine with the necessary accuracy the fire resistance of such structures in a fire other than standard.

Scientists made a significant contribution to the study of fire-retardant properties of coatings of protected reinforced concrete and steel structures during their tests under alternative fire conditions in [32–41]. However, these studies have not sufficiently studied the behaviour of steel structures for all possible temperature regimes, such as the hydrocarbon fire regime.

In [154] the issues of mathematical modelling of fire resistance of bearing steel structures of machine halls of power plants under the conditions of hydrogen combustion temperature regime, which is even more severe fire regime in contrast to the temperature regime of hydrocarbon fire, are considered. However, there are no reliable data on the use of the developed models for fire-retardant steel structures of machine halls of power plants.

[155] considers the influence of temperature regimes of hydrocarbon fire and fire regimes in tunnels according to the standards of Germany (RABT) and the Netherlands (RWS) on the value of the limit of fire resistance of reinforced concrete frames of tunnel structures, but the experimental tests of these building structures for such modes were not.

In [156, 157] the gradient-temperature criterion for calculation of fire resistance of elements of reinforced concrete designs from influence of high-intensity convective-radiation streams at large-scale combustion of hydrocarbons for various scenarios of fire development at petrochemical enterprises is scientifically substantiated: fireball, fire spills, flare burning, fire-flash.

Thus, when assessing fire resistance, scenarios of real or conditional fire are considered. Nominal temperature regimes, such as standard temperature regimes, are used for conditional fire scenarios. According to the results of the assessment carried out at nominal temperature regimes, building structures are classified according to fire resistance. In the case of fire-retardant materials, the classification applies to the protected structure containing these materials, but not to the fire-retardant materials themselves [158–162].

[158] describes the methodology used to restore thermal properties. This methodology can be used to model the behaviour of reactive flame retardant coatings. The results show that the proposed approach, based on modelling the behaviour of the reactive coating using equivalent thermal conductivity, can be used to quantify the fire-retardant effect of a protective coating.

In [159] experimental research of thermal behaviour of fire-retardant coverings for steel designs in the conditions of a real fire are presented. Coating properties such as specific heat, thermal conductivity and density have not yet been studied in detail, especially for real fire scenarios with different heating and cooling rates. In contrast to the standard temperature regime of the fire, which provides for a rapid and continuous increase in temperature, a real model of fire is presented (development phase, fully developed fire, cooling phase).

In [160] experimental and numerical studies of fire-retardant characteristics of water-soluble reactive coating for the protection of steel structures in the event of a real fire. Based on own laboratory tests the improved numerical model for modelling of characteristics of the investigated covering which includes thermophysical characteristics of material is developed: coefficient of ex-

pansion, thermal conductivity and heat capacity. However, the authors propose to use constant values of thermophysical characteristics, although the use of such temperature-dependent characteristics is a more accurate approach.

In [161] the basic tendencies in the field of protection of steel designs by means of reactive fire-retardant coverings are resulted. Given the importance of the use of coatings to increase the limits of fire resistance of steel structures, especially for the oil and gas industry, the paper provides an overview of research on the development of flame retardants and technologies for the creation of such tools.

[83] describes the results of research related to the development of reactive fire-retardant coatings to protect steel structures from fire. The main components of the developed compositions are described: binders, flame retardants, fillers, modifiers, additives, as well as the influence of climatic factors on the properties and characteristics of fire-retardant coatings. However, no data are provided on the use of coatings in arbitrary fire conditions.

[162] presents the results of an experimental study of fire-retardant steel plates exposed to three non-standard fire temperatures. The effective thermal conductivity of the coatings was calculated based on the measured temperatures in the furnace and on the steel plates. The results of experimental studies show that the fire-retardant characteristics of coatings strongly depend on the heating rate and the maximum temperature in the test furnace.

Thus, fire-retardant steel and reinforced concrete structures when used in buildings and structures of different functional purposes have different limits of fire resistance, which is provided by the use of fire-retardant substances with different properties and characteristics. The parameters of the formed fire-retardant coatings are influenced by the conditions under which the fire resistance tests of fire-retardant building structures take place. Therefore, when designing buildings and structures using fire-retardant steel and reinforced concrete building structures, it is necessary to consider the effects of fire temperatures on the values of fire resistance limits of fire-resistant steel and reinforced concrete building structures.

### **2.3.2 INFLUENCE OF CLIMATIC FACTORS ON FIRE-RETARDANT ABILITY OF COVERINGS OF FIRE-RESISTANT BUILDING CONSTRUCTIONS**

Shelf life of a flame retardant coating is the period during which a flame retardant is able to provide fire protection after its application.

Regulations are developed for each flame retardant, which must contain the technical and physicochemical characteristics of the flame retardant, including operating conditions (humidity and room temperature, etc.) and the shelf life of the flame retardant, which is determined according to climatic or periodic tests. The tests are intended to determine the ability of fire-retardant coatings for steel structures to retain their fire-retardant and performance properties during the service life specified by the manufacturer of these products.



The test method includes the method of accelerated aging and the method of long-term storage. The essence of the method of accelerated aging is to model the aging processes of fire-retardant coatings artificially and to determine the estimates before and after “accelerated aging”. The essence of long-term storage is to bookmark the samples for the period specified in the regulations for these fire retardants, and periodically check the estimated performance of fire-retardant coatings.

According to the methodology, the evaluation indicators include:

- thickness of fire-retardant coating;
- fire protection efficiency;
- coefficient of swelling;
- adhesion;
- impact strength;
- salinity;
- moisture absorption;
- corrosion on coated metal.

The samples are tested before and after accelerated aging. Cycles of simulation of aging of fire-retardant coatings are given in **Table 2.1**.

● **Table 2.1** Cycles of simulation of aging of fire-retardant coatings

Regimen name	Indicators of the mode for holding the coating	
	polymer	inorganic
Variable temperature and high humidity	– 4 hours in the humidity chamber at a temperature of plus $(40+2)$ °C and relative humidity $(97+3)$ %; – 2 hours cooling in the humidity chamber; – 3 hours keeping in a cold chamber at an air temperature minus $(45+2)$ °C; – relative humidity is not regulated	– 41 hours of saturation of the coating in water (soluble salts) at a temperature of 15–30 °C; – for 2 hours temperature decrease from –10 °C to –50 °C; – 2 hours at a temperature of –50 °C; – for 2 hours temperature rise from –50 °C to –10 °C; – for 1 hour temperature rise from –10 °C to $(50+2)$ °C
Aggressive gas environment	– 2 hours keeping the coating in the sulfur gas chamber at a temperature of $(40+2)$ °C and relative humidity $(97+3)$ %; – composition of SO <sub>2</sub> mg/m <sup>2</sup> of air	– 2 hours keeping the coating in the sulfur gas chamber at a temperature of $(40+2)$ °C and relative humidity $(97+3)$ %; – composition of SO <sub>2</sub> mg/m <sup>2</sup> of air
Solar radiation	– 7 years keeping in the chamber IP-1-3 at a temperature of 15–30 °C; – irrigation mode: irrigation 3 min – break 57 minutes	–
Maintenance in the laboratory	– 6 hours at an air temperature of 15–30 °C and relative humidity no more than 80 %	–

In the Republic of Belarus, such tests are conducted in accordance with [163]. This standard applies to flame retardants for wood, wood materials, fabrics, cable products and steel structures and establishes general technical requirements and test methods for such products. According to the provisions of the standard fire-retardant substances are classified:

- by type of product:
  - 1) impregnating (only for wood);
  - 2) varnishes;
  - 3) paints;
  - 4) plasters;
  - 5) impregnation for fabrics;
- under the conditions of application:
  - 1) in heating rooms;
  - 2) in unheated rooms;
  - 3) to protect external surfaces;
- on the solubility of the binder:
  - 1) water-soluble;
  - 2) organosoluble.

For impregnating agents, a method for determining the preservation of fire-retardant efficiency of impregnating agents for wood and strength indicators of fire-retardant wood has been established. The essence of the method is to determine the fire-retardant effectiveness of means and indicators of wood strength before and after accelerated aging. Samples are prepared in double quantity for testing.

For varnishes, paints and plasters the method of definition of preservation of fire-retardant efficiency and adhesion of a covering of fire-retardant varnishes, paints are established. The essence of the method is to preserve the fire-retardant efficiency and adhesion of the coating before and after accelerated aging. For testing fire-retardant coatings for metal, prepare samples in double quantities according to [164] (for coatings thicker than 0.2 mm) or [165] (for coatings thicker than 0.2 mm), and prepare at least 4 samples of metal plates, dimensions 210×210×2 mm. A flame retardant is applied to one surface of the sample in accordance with the technical documentation for a specific type of flame retardant. Prepared samples with the applied coating are dried for two days at a temperature of  $20 \pm 3$  °C and relative humidity from 45 % to 60 %. The tests are performed to determine the flame retardant efficiency according to the requirements [163] and adhesion according to [163] (for coatings thicker than 0.2 mm) or [164] (for coatings thicker than 0.2 mm). To test the spread of flame and thermal stability of fire-retardant varnishes and paints on cable products prepare samples in double quantity, as well as prepare two samples with a length of  $200 \pm 5$  mm and a diameter of 35 mm to 60 mm with the applied tool according to means.

8 cycles equate to 1 year of operation.

In the countries of the European Union, ETAG 000 and ETAG 018 [166–169] are in force, which apply to flame retardants that establish methods for estimating the service life of flame retardants.

---

It is established that depending on the environmental conditions under which the products will be operated after the application of flame retardants, there are categories described below.

Type X – fire-retardant coatings designed for use in all conditions (indoors, with partial exposure to the environment, with full exposure to the environment).

Cycles should be performed without interruption. 1 cycle is equal to 5 years of operation.  
Total: 35 days.

Type Y – fire-retardant coatings intended for indoor use or with partial exposure to the environment. Partial exposure includes temperatures below 0 °C but does not include rain exposure and provides limited exposure to ultraviolet radiation (ultraviolet power is not estimated).

Cycles should be performed without interruption. 1 cycle is equal to 5 years of operation.  
Total: 7 days.

Type Z1 – fire-retardant coatings intended for indoor use (except those intended for operation at temperatures below 0 °C) with high humidity.

Cycles should be performed without interruption. 10 cycles equal 5 years of operation.  
Total: 24 hours.

Type Z2 – fire-retardant coatings intended for indoor use (except those intended for operation at temperatures below 0 °C) without exposure to high humidity, which are classified in class Z1.

Cycles should be performed without interruption. 10 cycles equate to 5 years of operation.  
Total: 24 hours.

10 cycles equal 5 years of operation.

Tests to determine the service life of fire retardants for steel structures are carried out on the indicators of corrosion resistance and fire protection efficiency. The service life is determined by comparing the quality indicators of the samples that were not affected with the quality indicators of the samples that were subjected to artificial aging.

A test result is considered to be positive if the average period of time during which the critical temperature for steel is reached (500 °C) determined during the service life tests exceeds 85 % of the average value obtained during the initial tests. In order to eliminate the influence caused by the unequal thickness of the coating, the relationship between its thickness and the temperature value can be considered linear.

Based on the results of the analysis of regulatory documents to determine the expiration date, the following conclusions can be drawn:

1. The main indicators for determining the shelf life of fire retardants are indicators of fire protection efficiency of fire retardants.

2. Based on the results of the analysis of normative documents and literature sources, it has been established that the vast majority of fire-retardant coatings are characterized by the following operating conditions (placement categories):

- in the open area;
- under a canopy, in a room that is not heated;
- in a dry, heated room.

3. The normative documents of the European Union establish various methods for determining the indicators of fire-retardant effectiveness of fire-retardant means.

For the correct choice of test methods when conducting accelerated tests, it is necessary to choose the operating conditions of the fire-retardant coating. At present in Ukraine, methods of accelerated tests for resistance to climatic factors are given in [170].

In the **Tables 2.2** and **2.3** describe the climatic conditions given in various regulations when used in a dry heated room and under a canopy, in a room that is not heated, respectively.

● **Table 2.2** Climatic conditions during accelerated tests that simulate operation in a dry heated room

Normative document	Climatic conditions	Number of cycles corresponding to 1 year of operation
GOST 53292-2009	1) temperature $(60 \pm 5)$ °C for 8 hours; 2) temperature $(23 \pm 5)$ °C for 16 hours in a desiccator filled with water, with a relative humidity of 100 %; 3) temperature $(60 \pm 5)$ °C for 8 hours in the oven; 4) temperature $(23 \pm 5)$ °C for 16 hours in the desiccator, with a relative humidity above it $(65 \pm 5)$ %	1 cycle
STB 11.03.02	1) temperature $(55 \pm 2)$ °C, relative humidity $(90 \pm 3)$ % for 10 hours; 2) temperature $(20 \pm 2)$ °C, relative humidity $(90 \pm 3)$ % for 2 hours; 3) temperature $(60 \pm 2)$ °C, relative humidity not more than 80 % within 10 hours; 4) temperature $(20 \pm 2)$ °C, relative humidity not more than 80 % for 2 hours	8 cycles
ETAG 028	1) temperature $(40 \pm 3)$ °C, relative humidity $(98 \pm 2)$ % for 8 hours; 2) temperature $(23 \pm 3)$ °C for 16 hours	2 cycles

Analysis of the works of scientists [171–179] and regulations on fire protection, developed in accordance with regulations on fire safety, makes it possible to determine the scope of fire protection coatings. It is established that most fire-retardant coatings are used in a dry room that is heated or under a canopy, in a room that is not heated.

In [171], a study was conducted to determine the influence of climatic factors, such as the effects of ultraviolet radiation, humidity, temperature and aggressive environment on the fire-retardant ability of reactive flame retardant coating based on epoxy resin, which includes ammonium polyphosphate, melamine and titanium dioxide. Fire-retardant steel plates were subjected to various conditions of accelerated aging: humidity 80 % at 70 °C for 2 months and static bath with

and without NaCl (5 g/l) at 20 °C for 1 month and tested in a fire furnace at hydrocarbon fire. The results show a slight decrease in the fire-retardant properties of the studied coatings after climatic exposure. However, the paper does not show the effect of thermophysical characteristics of the fire-retardant coating on its fire-retardant properties after such exposure.

● **Table 2.3** Climatic conditions during accelerated tests that simulate operation under a canopy in a non-heated room

Normative document	Climatic conditions	Number of cycles corresponding to 1 year of operation
STB 11.03.02	1) temperature (40±2) °C, relative humidity (90±3) % within 6 hours; 2) temperature (20±2) °C, relative humidity (90±3) % for 2 hours; 3) temperature minus (15±3) °C, relative humidity not more than 80 % for 3 hours; 4) temperature (60±2) °C, relative humidity not more than 80 % within 7 hours; 5) temperature (20±2) °C, relative humidity not more than 80 % for 6 hours	8 cycles
ETAG 028	1, 2 day: – temperature (20±3) °C, relative humidity (95±5) % within 6 hours; – temperature (70±3) °C, relative humidity (20±5) % within 6 hours; – temperature (20±3) °C, relative humidity (95±5) % within 6 hours; – temperature (70±3) °C, relative humidity (20±5) % within 6 hours. 3, 4 day: – temperature (20±3) °C, relative humidity (95±5) % within 6 hours; – temperature (30±3) °C, relative humidity (40±5) % within 6 hours; – temperature (40±3) °C, relative humidity (95±5) % within 6 hours; – temperature (30±3) °C, relative humidity (40±5) % within 6 hours 5–7 days: – temperature minus (20±3) °C for 6 hours; – temperature (40±3) °C, relative humidity (95±5) % within 6 hours; – temperature minus (20±3) °C for 6 hours; – temperature (40±3) °C and relative humidity (95±5) % for 6 hours	1 cycle 5 years of operation

[172] describes fire-retardant coatings, which include graphite as a catalytically active additive, which improves the performance of the coating, such as swelling rate, elasticity, density and

homogeneity of the coke layer, which positively affects the fire-retardant ability of the coating. However, the researchers did not pay attention to the work of fire-retardant coating after exposure to climatic factors.

In [173] the operational properties of the charred layers formed as a result of the synthesis of reactive flame retardant coatings and methods of improving these properties with various additives mixed with the original composition are considered. The results show that the additives tend to change the microstructure of the semi-coke, which undergoes some transformations and this is confirmed by the increase in the thickness of the coating and its stability on the protected surface.

In [174] the compositions and methods of protection of reactive fire-retardant coatings, the influence of atmospheric conditions on the coefficient of swelling of coatings and methods of improving their fire-retardant and anticorrosive properties are described. Under the influence of atmospheric conditions, the fire-retardant properties of coatings are reduced because of leaching of components that cause the formation of a swollen layer of semi-coke. It is concluded that the development of reactive flame retardants includes not only the process of improving the insulation and stability of the charred layer of foam coke, but also improving the flame retardant properties of coatings under the influence of various climatic factors.

In [175] the results of an experimental study of the deterioration of the characteristics of two types of reactive fire-retardant coatings after different test cycles by the method of accelerated hydrothermal aging are presented. After testing the sample for aging, a fire resistance test was performed to determine the heating temperature of the fire-retardant steel plate. As a result, it was found that compared to samples that did not undergo hydrothermal aging, after 42 cycles of hydrothermal aging (to simulate 20 years of environmental exposure), the effective thermal conductivity of fire-retardant coating type U was 50 % higher and fire-retardant coating type A 100 % higher than the coating without such exposure. This increase in effective thermal conductivity has led to an increase in the temperature of the steel plate by 150 °C and 220 °C higher than the temperature of the steel plate without hydrothermal aging.

In [176] the results of experimental and numerical simulations for obtaining the thermal conductivity of two types of reactive flame retardant coatings after accelerated aging are presented. The main objective of the study was to verify the accuracy of the thermal conductivity model for fully expanded semi-coke coating, which was assumed to depend on the thickness of the expansion, as well as the size and distribution of bubbles. The results of measurements of increased coating thickness and bubble size show that accelerated aging negatively affects the insulating characteristics of the coating: reducing the thickness of the expansion and increasing the size of the bubbles, which leads to an increase in thermal conductivity.

In [177] the protective effect of the top coating on the reactive fire-retardant coating under conditions of corrosion with hydrochloric acid, accelerated ultraviolet aging and natural weather was studied. It was found that the protective effects are noticeable under any aging conditions. When tested for corrosion with hydrochloric acid, the uncoated coating sample lost its flame retardant ability after 48 hours of immersion. Under conditions of accelerated ultraviolet aging,

the fire-retardant ability of the coating significantly deteriorated after 20 days of aging due to hydrolysis and photo-oxidation of the components. In the process of natural weathering, the fire-retardant ability of the coating without a finish is significantly reduced after exposure to high levels of precipitation and ultraviolet radiation, which occur in summer. Therefore, a protective topcoat is considered indispensable for fire retardant coatings used outdoors to provide the best long-term fire-retardant performance.

[178] describes passive fire-retardant coatings, which are widely used in the oil, gas and chemical industries to protect marine and terrestrial objects from fire after prolonged weathering. The paper describes the effect of atmospheric influences on six widely used epoxy reactive flame retardant coatings and one cement-based coating. The results show that the weather changes the physical shape of the coating during its operation, causes corrosion of fire-retardant steel structures of marine and terrestrial objects and affects the fire-retardant ability of coatings, and thus the fire resistance of fire-resistant steel structures.

In [179] the influence of the degree of polymerization of ammonium polyphosphate on the shelf life of water-based flame retardant coatings was studied. As a basis in fire-retardant coatings used 5 types of ammonium polyphosphate with different degrees of polymerization. After the tests on accelerated aging, the influence of climatic factors on the fire-retardant ability of coatings as a result of tests on fire resistance was studied in detail.

From the above analysis it is clear that the assessment of fire resistance of fire-retardant steel and reinforced concrete building structures without taking into account the influence of climatic factors, aggressive environment will lead to erroneous determination of fire resistance of fire-resistant building structures. And the existing methods of assessing the fire resistance of fire-retardant building structures are deprived of the algorithm for taking into account such influences. Therefore, the development of methods for assessing the fire resistance of fire-retardant steel and reinforced concrete structures, which would take into account the impact of various factors on the accuracy of assessment, is an urgent problem, the solution of which will ensure the stability of buildings and structures during fires and emergencies, through the use of fire-retardant steel and reinforced concrete structures in construction, taking into account all types of impact on structures.

## 2.4 SYSTEM ANALYSIS OF THE PROCESS OF ENSURING FIRE RESISTANCE OF BUILDING STRUCTURES

The analysis showed that the assessment of fire resistance of fire-retardant building structures and fire-retardant ability of coatings of building structures by the calculation-experimental method is an urgent and insufficiently studied problem. This is due to the presence of undisclosed features of improving the efficiency of the calculation and experimental method to determine the limits of fire resistance of load-bearing reinforced concrete and steel structures. These features can be taken into account by substantiating the parameters of mathematical models that describe

the physicochemical processes when heating these structures using fire-retardant materials with certain parameters in standard and alternative fire modes [81–181].

In [81] the processes occurring in reactive fire-retardant coatings for the protection of steel structures under different test conditions (temperature conditions in the furnace) are considered. The onset of swelling of the coating is a key factor in ensuring the effectiveness of thin reactive fire-retardant coatings to ensure fire resistance of the fire-retardant steel structure during a fire. The results of research obtained because of this work determined the threshold of the beginning of swelling in terms of heating temperature of the steel structure and coating during tests and concluded that the beginning of swelling is directly affected by heating conditions and initial thickness of the flame retardant coating.

[107] highlighted the problem of the current design structure based on furnace fire resistance tests at standard fire temperatures, and the current methodology was questioned due to its oversimplification, limitations, and uncertainties. To solve this problem, integrated approaches and methodologies have been proposed to study the effectiveness of reactive flame retardant coatings. This review examines the latest developments in the field of fire resistance tests and analysis of fire resistance of fire-resistant steel structures with reactive fire-retardant coatings. In addition to the chemical composition, the key determinants that affect the fire resistance of fire-resistant steel structures are determined: the initial and ultimate heat transfer conditions, the thickness of the coating, heating conditions and test method for fire resistance.

In [180], a numerical model was developed to predict the limit of fire resistance, including such material properties as thermal conductivity and the thickness of the reactive flame retardant coating. The temperature-time dependence of the thermal conductivity of reactive flame retardant coatings was calculated by solving inverse thermal conductivity problems in accordance with Eurocodes (EN 1993-1-2 and EN 1994-1-2). As a result, it is established that the equation of Eurocodes does not give the exact dependence of the thermal conductivity of the coating on the temperature for use in numerical simulations of heat transfer.

In [74] experimental studies of the characteristics of reactive fire-retardant coatings in standard and non-standard fire conditions were conducted. To study how different heating conditions and heating rates affect the behaviour of two different flame retardant coatings (solvent-based and water-based), three different experimental installations were used, corresponding to three different fire scenarios in electric furnace, gas furnace and cone heater. The results showed that water-based paint works better at low heating rates, while solvent-based paint showed better results at high heating rates and was not effective at very low heating rate. Thus, the study confirms that the existing procedure for the development of reactive flame retardant coatings has disadvantages, consisting in disregard by paint developers of the conditions under which the paint will be used, namely: heating conditions and heating rate in case of fire.

The authors [181] presented a new test methodology for studying the characteristics of reactive coatings under non-standard heating regimes, based on test data in the furnace of fire-resistant steel structures. This methodology has advantages such as reliability, reproducibility,

---



versatility, speed and cost of testing. The effective coefficient of thermal conductivity, variable over time, of commercially available reactive coating under the influence of heat flow at different temperatures of the fire is investigated. It is shown that the heating rate and the thickness of the coating do not significantly affect the value of the effective thermal conductivity.

Improving the fire resistance of building structures can be achieved through the use of fire-retardant substances that form on the surface of the coating, which should be applied with the required minimum thickness, which will provide a normalized limit of their fire resistance [182, 100].

In [100] the results of an experimental study of the effect of protective coating on the fire-retardant properties of reactive fire-retardant coatings by comparing temperatures in fire-retardant steel elements and effective thermal conductivity in their tests under standard fire temperatures are presented. However, the authors did not take into account other temperature regimes than the standard one. It is necessary to consider the thermophysical characteristics of fire-retardant coatings [183–186].

In [183] the results of the research on the calculation of the constant effective thermal conductivity of reactive fire-retardant coatings under the influence of various factors (type of coating, coating thickness, coefficient of steel cross-section, fire temperature) are presented. However, the authors have not investigated the use of the coefficient of thermal conductivity, which depends on temperature. This approach provides more accurate data when assessing the fire resistance of fire-resistant steel structures.

In [184], the authors present data on the modelling of non-stationary heating of fire-retardant steel structures with reactive fire-retardant coatings. The procedure consists of calculating the coefficient of thermal conductivity of the fire-retardant coating, which depends on the heating time of the fire-retardant structure in the test furnace at a certain fire mode. The use of this approach is more accurate compared to [183], as the thermal conductivity of the fire-retardant coating is a function of temperature and modelling using it leads to a more accurate assessment of fire resistance with minimal errors.

In [185] it is proposed to find the thermophysical characteristics of fire-retardant coatings for protection of steel frame structures by solving inverse thermal conductivity problems, which allows to predict with sufficient accuracy for engineering calculations the fire-retardant ability of steel structures using fire resistance tests.

In [186] the research program “Optimization of the use of reactive fire-retardant coatings for fire protection of steel structures” is presented. Experimental studies of fire-retardant beams and coated columns directly connected to the enclosing elements are presented. In addition, numerical simulation is performed to calculate the temperature fields of steel structures with reactive fire-retardant coating. As a new development, the numerical model takes into account the process of expanding the fire protection coating.

To date, there is a problem that there is insufficient data on the values of the required minimum thickness of fire-retardant coatings for fire-retardant reinforced concrete and steel structures during their testing in alternative fire conditions and after exposure to climatic factors.

As for the methods of determining the fire-retardant effectiveness of fire-retardant means for such fire-retardant structures, as a rule, an experimental method is used, which involves the use of their fragments, which is quite expensive and time-consuming [187, 188].

In addition, during such tests it is possible to use only a certain temperature regime, which does not always correspond to the peculiarities of the operation of a particular structure [189–191].

In [189], by conducting tests for fire resistance, as well as other tests of physical and chemical properties, the optimal ratio of the composition of the flame retardant for the manufacture of flame retardant coatings for fire protection of tunnel structures was determined. The experimental results confirm that this coating increases the fire resistance of reinforced concrete structures of tunnels and has better adhesive properties compared to most existing coatings for use in temperature conditions of fire in tunnels.

In [190] the method of modelling the general characteristics of reactive fire-retardant coatings at different fire temperatures for fire protection of steel structures is presented. The aim of the study was to find one common set of properties that will predict the fire-retardant characteristics of the coating under different heating conditions of fire-retardant structures in the furnace (slow, fast and standard) for the same steel sheet thickness and coating thickness.

[191] presents reactive flame retardant coatings for different applications. To date, there is no universal method for assessing the fire resistance of fire-resistant steel structures, except for the standard temperature of the fire, and the scenario of a real fire often plays an important role that is not considered in the calculations. The effective coefficient of thermal conductivity is proposed to be calculated on the basis of intermediate tests for fire resistance.

### CONCLUSIONS ON SECTION 2

1. Experimental methods for assessing the fire resistance of fire-retardant steel and reinforced concrete structures are the most accurate and provide the most reliable information on the limits of fire resistance of building structures in terms of their testing at standardized fire temperatures. However, along with the advantages of such methods have a number of disadvantages. Such shortcomings include: the complexity of manufacturing, preparation and testing of fire resistance of large building structures, high material costs for testing in accredited laboratories. Disadvantages include the inability to transfer the test results of one structure to structures of all sizes and types, poor adhesion of fire-retardant coating to the protected surface during fire, the problem of maintaining the integrity of the fire-retardant coating, and therefore, failure to perform its protective functions. All this imposes some restrictions on the use of only the experimental method of assessing the fire resistance of fire-resistant steel and reinforced concrete structures in view of the above shortcomings.

2. The use of calculation methods to assess the fire resistance of unprotected and fire-resistant steel and reinforced concrete building structures, compared to experimental, has a number

of advantages, such as the ability to perform calculations without high material costs, although certified software must be expensive and highly qualified specialists who will be able to correctly and reasonably set the parameters of the model of the thermal state of fire-resistant building structures. After all, inaccuracies in setting initial, boundary conditions and inaccuracies in the use of mathematical and physical models of thermal processes in fire-resistant structures under fire, can lead to erroneous assessment of fire resistance of fire-retardant building structures, and thus to miscalculations in the design of buildings and structures.

3. Assessment of fire resistance of fire-retardant steel and reinforced concrete building structures without considering the influence of climatic factors and aggressive environment leads to erroneous determination of the limits of fire resistance of fire-resistant building structures. And the existing methods of assessing the fire resistance of fire-resistant building structures are deprived of the procedure for taking into account such effects. Therefore, the development of methods for assessing the fire resistance of fire-resistant steel and reinforced concrete building structures, which would consider the influence of climatic factors on the accuracy of assessment, is an urgent problem, the solution of which will ensure stability of buildings and structures.

4. The conducted analysis allows to state the tendency of spreading the application of the calculation-experimental method for estimating the limits of fire resistance of fire-retardant reinforced concrete and steel building structures and fire-retardant ability of coatings for such structures. Since this method allows taking into account the importance of thermophysical characteristics of fire-retardant coatings and heat transfer processes in the structure under different fire conditions, its use is appropriate when determining the limits of fire resistance of protected reinforced concrete and steel structures and fire-retardant ability of coatings for such structures.

5. Thus, there is a need to develop calculation and experimental methods for assessing the fire resistance of fire-retardant steel and reinforced concrete building structures, which would consider all the above miscalculations and have sufficient accuracy for engineering calculations when estimating fire resistance, the level of fire safety of facilities through their fire protection with standardized parameters.

**ABSTRACT**

---

This section develops a mathematical model and calculation-experimental method for estimating fire resistance of fire-retardant reinforced concrete structures, considers the algorithm of the proposed method, describes the procedures for its implementation, tested the effectiveness of the proposed method in identifying the relationship between parameters) and fire resistance of fire-resistant multi-hollow reinforced concrete floor.

**KEYWORDS**

---

Physical model, mathematical model, efficiency of the method, fire-retardant reinforced concrete structures.

**3.1 DEVELOPMENT OF PHYSICAL AND MATHEMATICAL MODELS OF FIRE RESISTANCE OF FIRE-RETARDANT REINFORCED CONCRETE STRUCTURE**

The main operational characteristics of buildings and structures for industrial and civil purposes include durability, reliability, efficiency, which are largely due to the peculiarities of the thermal state of their structural elements (structures). The need to study the thermal state of fire-resistant building structures arises in the design, construction and operation of buildings and structures, in the modernization and transfer of buildings to other modes of operation, intensification of technological processes. This determines the complexity of the procedure for studying the thermal state of fire-resistant building structures of buildings and structures, which ultimately comes down to the tasks of optimization and management of systems with distributed parameters and includes the following stages: identification of basic physical features; development and substantiation of the mathematical model of the researched process; development and selection of appropriate methods and tools for solving and implementing the formulated tasks; research of mathematical model, checking the adequacy of mathematical model; evaluation of the obtained results in the set of requirements for the studied processes, states and methods of their management; choice of rational design solutions and modes of operation of the building; determination of optimal parameters of the studied system. The procedure for developing a method for assessing the fire resistance of fire-retardant reinforced concrete structures is considered on the example of multi-hollow reinforced concrete floor slabs as the most complex structure in terms of geometry, the presence of voids in which complex convective-radiative heat transfer overlap.

Since reinforced concrete structures often do not meet the requirements of fire safety in relation to the normalized values of their fire resistance, it is important to ensure and increase the fire resistance of such structures by their fire protection using a variety of substances and materials. When designing fire protection of such structures, the question of the accuracy of calculating the thermal state of both protected and unprotected multi-hollow reinforced concrete floors is acute, which is largely determined by the accuracy of the model parameters that ensure its adequacy to real heat transfer processes. Such parameters include thermal conductivity, specific heat capacity of both concrete and fire protection coating, and test conditions (number of samples, average volume temperature and humidity in the test chamber) to be provided during the coating performance determination process.

### 3.1.1 ALGORITHM FOR DEVELOPING A MATHEMATICAL MODEL

In developing the mathematical model used structural and logical scheme, shown in **Fig. 3.1** [192].

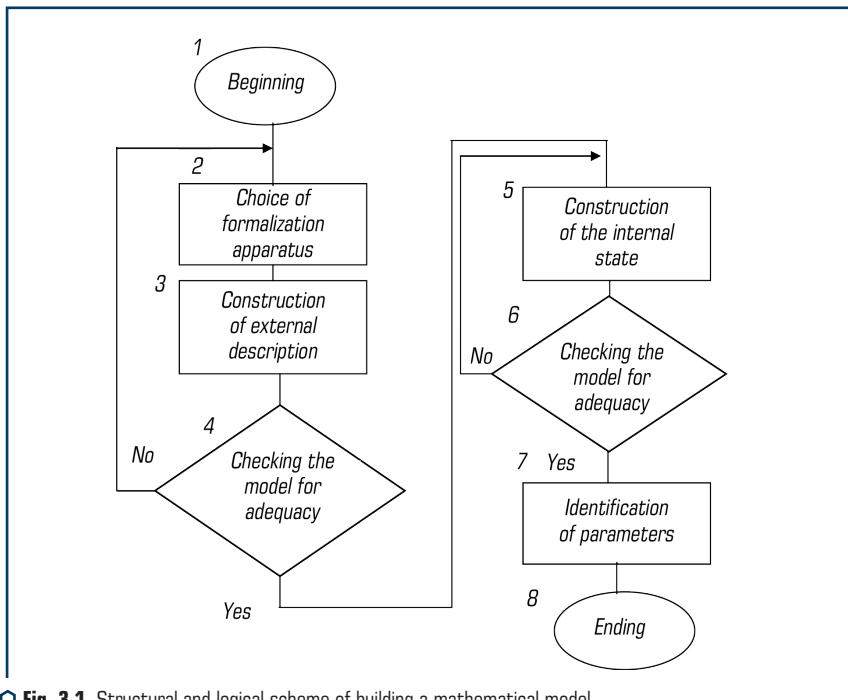
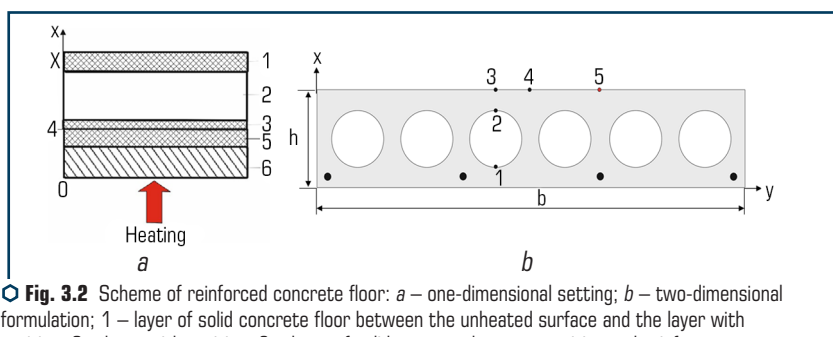

Fig. 3.1 Structural and logical scheme of building a mathematical model

One of the stages of creating a method for assessing the fire resistance of fire-retardant reinforced concrete structure is the construction of adequate physical and mathematical models of thermal processes occurring in the studied reinforced concrete floors with coating.

### 3.1.2 INITIAL AND BOUNDARY CONDITIONS IN THE CONSTRUCTION OF THE MODEL FOR THE THERMAL TASK

In developing a mathematical model [193], a physical model with a division of the plate into layers was used, as shown in **Fig. 3.2**.



**Fig. 3.2** Scheme of reinforced concrete floor: *a* – one-dimensional setting; *b* – two-dimensional formulation; 1 – layer of solid concrete floor between the unheated surface and the layer with cavities; 2 – layer with cavities; 3 – layer of solid concrete between cavities and reinforcement; 4 – reinforcement layer; 5 – a layer of solid concrete from the reinforcement to the heating surface; 6 – plaster coating; *h* – the thickness of the plate; *b* – width of the plate; *y* – coordinate along the width of the structure; *x* – the coordinate of the thickness of the structure

The physical model of fire-retardant reinforced concrete floor consists of six layers with a thickness of  $\delta_1, \delta_2, \delta_3, \delta_4, \delta_5, \delta_6$  (**Fig. 3.2, a**). The total thickness of the floor with the coating puts the sum of the thickness of the individual layers of the floor. During the test, the lower floor surface is heated by convective-radiation heat exchange mechanisms from hot gases in a furnace with a temperature  $T_{c1}$ , which is close to the standard fire curve (or other alternative fire mode), and heat transfer coefficient  $\alpha_{c1}=25 \text{ W/m}^2\cdot^\circ\text{C}$  for standard temperature fire mode and  $50 \text{ W/m}^2\cdot^\circ\text{C}$  for the temperature mode of the hydrocarbon fire. The upper surface of the floor is cooled by convection into the ambient air with temperature  $T_{c2}$ , the heat transfer coefficient from the unheated surface  $\alpha_{c2}$  is assumed to be temperature dependent [194].

In the middle of the floor heat is transferred not only by thermal conductivity, but also by convective-radiation mechanisms of heat exchange in the floor cavities. The condition of ideal thermal contact between separate layers of overlapping is accepted.

When heated from below (**Fig. 3.2, a**), the corresponding amount of heat by thermal conductivity through the lower layer of concrete over the entire floor area reaches the voids, heating

first the lower part. Next, the same thermal conductivity mechanism heats the concrete bridges from the bottom to the top of the voids (with a much smaller variable area of the bridges), and then – the upper unheated layer of concrete again over the entire floor area. In parallel with the transfer of heat by thermal conductivity through the jumpers through the cavities, thermal energy is transferred by free convection of air and radiation from the lower warmer to the upper colder cylindrical walls of the cavities.

The mathematical model of the thermal conductivity process in such a six-layer system in the Cartesian coordinate system, which describes the physical model discussed above, is a one-dimensional equation of thermal conductivity with a combination of radiant heat transfer and boundary conditions of the third kind on the heating surface, and boundary conditions of the third kind from an unheated surface that takes into account the ambient temperature [195]. The temperature distribution  $T$  in the fire-retardant reinforced concrete floor is described by a system of equations:

$$C_v(x, T) \frac{\partial T}{\partial \tau} = \frac{\partial}{\partial x} \left( \lambda(x, T) \frac{\partial T}{\partial x} \right), \quad (3.1)$$

where  $T = T(x, y, \tau)$ , initial condition  $\tau = 0, T(x, y, 0) = T_0 = \text{const}$ ,

$$\lambda_{\text{ff}} \frac{\partial T(0, \tau)}{\partial x} = \alpha^* [T_{c1}(\tau) - T(0, \tau)], \quad (3.2)$$

$$\alpha^* = \alpha_{c1} + \frac{C_0 \varepsilon}{T_{c1}(\tau) - T(0, \tau)} \left\{ \left[ \frac{T_{c1}(\tau)}{100} \right]^4 - \left[ \frac{T(0, \tau)}{100} \right]^4 \right\}, \quad (3.3)$$

boundary condition of convective heat exchange with the environment at the boundary  $X = X_6$  (multilayer wall with a sample):

$$\lambda_M \frac{\partial T(X, \tau)}{\partial x} = \alpha^{**} [T(X, \tau) - T_{e2}], \quad (3.4)$$

$$\alpha^{**} = \alpha_{e2} + \frac{C_0 \varepsilon}{T(X, \tau) - T_{e2}(\tau)} \left\{ \left[ \frac{T(X, \tau)}{100} \right]^4 - \left[ \frac{T_{e2}(\tau)}{100} \right]^4 \right\},$$

$$\alpha_{c2} = A [T(X, \tau) - T_{e2}(\tau)]^{0.33}, \quad (3.5)$$

where  $C_v$  – specific volumetric heat capacity;  $\lambda$  – thermal conductivity;  $T$  – temperature;  $\tau$  – time;  $x$  – coordinate;  $\alpha_{c1}$  – heat transfer coefficient from the heating surface of the fire-retardant coating or heated concrete;  $\alpha_{c2}$  – heat transfer coefficient from the unheated floor surface;

$C_0$  – the emissivity of a completely black body ( $C_0=5,67$ );  $\varepsilon$  – the coefficient of radiation of the surface of the fire-retardant coating or heated concrete;  $T_{c1}$  – the temperature of the hot gases in the furnace during the test;  $T_0$  – initial floor temperature before the test. The heat transfer coefficient from the heating surface of the flame retardant coating or concrete heated  $\alpha_{c1}$  is assumed to be 25 W/(m<sup>2</sup>·°C) (for standard temperature regime) and 50 W/(m<sup>2</sup>·°C) (for hydrocarbon fire temperature regime), coefficient radiation of the surface of the fire-retardant coating or heated concrete  $\varepsilon=0.7$ . The heat transfer coefficient from the unheated floor surface  $\alpha^{**}$  (3.4), (3.5) also considers the convective  $\alpha_{c2}$  and radiative heat exchange from the horizontal surface ( $A=1.16$ ) to the environment. The multilayeredness of the considered model is considered by the dependences  $C_v$  and  $\lambda$  on the coordinate.

The two-dimensional mathematical model was a system of equations:

$$\rho C_p \left( \frac{\partial T}{\partial \tau} + V_x \frac{\partial T}{\partial x} + V_y \frac{\partial T}{\partial y} \right) = \frac{\partial}{\partial x} \left( \lambda \frac{\partial T}{\partial x} \right) + \frac{\partial}{\partial y} \left( \lambda \frac{\partial T}{\partial y} \right), \quad (3.6)$$

equation of air motion in a cavity with free convection:

$$\rho \left( \frac{\partial V_x}{\partial \tau} + V_x \frac{\partial V_x}{\partial x} + V_y \frac{\partial V_x}{\partial y} \right) = \rho g - \frac{\partial P}{\partial x} + \frac{\partial}{\partial x} \left( \mu \times \frac{\partial V_x}{\partial x} \right) + \frac{\partial}{\partial y} \left( \mu \times \frac{\partial V_y}{\partial y} \right), \quad (3.7)$$

$$\rho \left( \frac{\partial V_y}{\partial \tau} + V_x \frac{\partial V_y}{\partial x} + V_y \frac{\partial V_y}{\partial y} \right) = - \frac{\partial P}{\partial y} + \frac{\partial}{\partial x} \left( \mu \times \frac{\partial V_x}{\partial x} \right) + \frac{\partial}{\partial y} \left( \mu \times \frac{\partial V_y}{\partial y} \right), \quad (3.8)$$

continuity equation for air in the cavity:

$$\frac{\partial(\rho)}{\partial \tau} + \frac{\partial(\rho V_x)}{\partial x} + \frac{\partial(\rho V_y)}{\partial y} = 0, \quad (3.9)$$

equation of state of compression of gas for air in the cavity:

$$P \cdot V = \frac{R \cdot T}{m}, \quad (3.10)$$

equation of radiative heat exchange between the walls of the floor cavities with air transparent to radiation rays:

$$\frac{\partial q_r(x,y)}{\partial l} = \varepsilon \frac{\sigma T^4}{\pi} + \frac{1}{4\pi} \int_0^{4\pi} q_r(x,y) d\phi, \quad (3.11)$$



boundary conditions of radiation-convective heat exchange from heating and non-heating surfaces according to (3.1)–(3.5);

conditions of symmetry (absence of heat exchange) on the side faces of the periodic part of the considered reinforced concrete slab (**Fig. 3.3, b**):

$$\frac{\partial T(x,0,t)}{\partial y} = 0, \quad \frac{\partial T(x,y,t)}{\partial y} = 0. \quad (3.12)$$

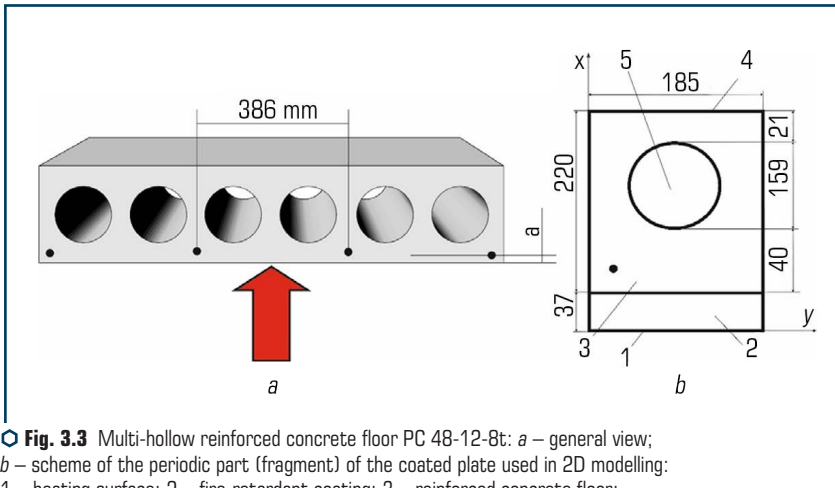

**Fig. 3.3** Multi-hollow reinforced concrete floor PC 48-12-8t: *a* – general view; *b* – scheme of the periodic part (fragment) of the coated plate used in 2D modelling: 1 – heating surface; 2 – fire-retardant coating; 3 – reinforced concrete floor; 4 – unheated surface; 5 – cavity (round cavity) floor

In (3.6)–(3.12):  $\mu$  – dynamic viscosity;  $q_r$  – radiation flux on the surface of the cavity with the coordinate  $x$  and  $y$  in the direction  $l$ ;  $d\phi$  – change of angular coefficient;  $\sigma$  – Stefan-Boltzmann constant;  $V$  – the volume of air in the cavity;  $P$  – air pressure in the cavity;  $g$  – free fall acceleration;  $R$  – universal gas constant.

Heterogeneity (concrete, air in cavities, fire-retardant coating) in the considered model is considered by the dependences  $C_v$ ,  $\rho$  and  $\lambda$  on the coordinates  $x$  and  $y$ .

There are two approaches in setting parameters for modelling the thermal state and fire resistance of both fire-retardant and unprotected multi-hollow reinforced concrete floors:

1) setting parameters from regulatory documents (DBN, DSTU, Eurocodes and other reference sources);

2) setting the parameters found by the results of tests of building structures for fire resistance (solving inverse and direct problems of thermal conductivity) [196].

Both approaches are widely used in the practice of calculations of stationary and non-stationary heating of fire-retardant multi-hollow reinforced concrete floors in the design, reconstruction, construction of new facilities [197, 198].

However, the values of the fire resistance of multi-hollow reinforced concrete slabs found using such approaches differ, as inaccuracy in setting or using such parameters can lead to erroneous determination of the fire resistance of the studied structures. This can negatively affect the main indicators of fire statistics: deaths and injuries in fires, the number of fires, the number of destroyed and damaged buildings.

### 3.2 DEVELOPMENT OF A STRUCTURAL-LOGICAL SCHEME OF THE COMPUTATIONAL-EXPERIMENTAL METHOD

According to the developed physical and mathematical models, the computational-experimental method for estimating the fire resistance of fire-retardant reinforced concrete structures is a way to analyze, optimize and predict the studied heat and mass transfer processes in fire-retardant reinforced concrete structures based on computer numerical with the help of experimental information about the studied process and the solution of inverse thermal conductivity problems. The basis of the method is a mathematical (calculated, numerical) model of the studied physical process, and the experiment (experimental data) is an auxiliary component necessary to ensure the adequacy of the selected model [199].

The main components of the calculation and experimental method for assessing the fire resistance of fire-retardant reinforced concrete structures are:

1. Calculation model of the physical process.
2. Experimental data needed to ensure the adequacy of the process model.
3. Methods of identifying the parameters of the selected process model in order to ensure its adequacy.
4. An adequate model is obtained, which is then used to solve the tasks of analysis, optimization or forecasting of the studied physical process.

As a result, the computational-experimental method consists of the components presented in **Fig. 3.4** [200].

As can be seen from **Fig. 3.4**, the object under study and the mathematical model describing the main physical processes occurring in the object allow to obtain, respectively, the experimental characteristic of temperatures ( $T_E$ ) and calculate the model characteristic of properties ( $T_M$ ). In turn, these characteristics depend on several input parameters  $P$  of physical or technological nature.

In our case, such parameters  $P$  include the thermophysical characteristics of concrete and fire-retardant coating – thermal conductivity and heat capacity. The parameters  $P$  are usually unknown, and their determination is possible by solving the inverse problems of thermal conductivity according to experimental measurements of  $T_E$ . The solution of the inverse problems of thermal

---

conductivity is to find such values of  $P$  for which the calculated ( $T_M$ ) and experimental ( $T_E$ ) values of some characteristics (in our case thermal) become close to each other.

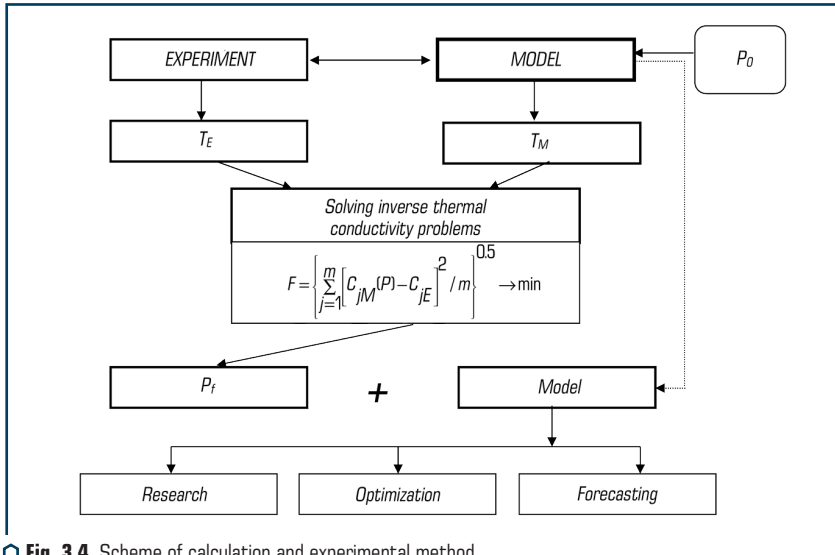

Fig. 3.4 Scheme of calculation and experimental method

The criterion for the proximity of these characteristics is most often the value:

$$F(P) = \sqrt{\frac{\sum_{j=1}^m (T_{M,j} - T_{E,j})^2}{m}} \approx \delta, \quad (3.13)$$

where  $m$  – the number of experimental measurements used to solve the inverse problem;  $\delta$  – rms measurement error.

The parameters  $P$  of the studied process obtained by solving the inverse problems of thermal conductivity are used based on the same model to solve the main engineering problems of analysis – optimization of parameters or forecast (Fig. 3.4). In our case – to assess the fire resistance of fire-retardant reinforced concrete structures. Solving inverse problems is an auxiliary procedure designed to ensure the adequacy of the chosen model to the physical processes under consideration [201]. The scheme of the developed calculation and experimental method for assessing the fire resistance of fire-retardant reinforced concrete structures and the procedure for its application are shown in Fig. 3.5.

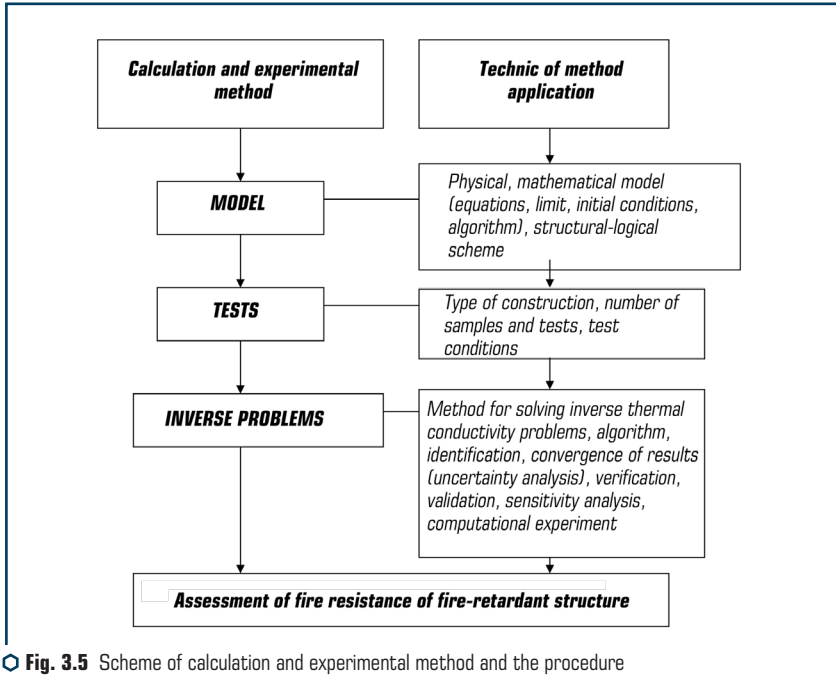

Fig. 3.5 Scheme of calculation and experimental method and the procedure for its implementation

Thus, the scheme of the computational-experimental method consists of the following stages (Fig. 3.5):

1. Development of physical and mathematical models of the thermal state of fire-retardant reinforced concrete structures.
2. Carrying out fire resistance tests or field fire tests (part of a structure or a sample of reduced dimensions), which are reduced to temperature measurements on samples and deformation of samples (for load-bearing structures) and in a fire furnace at specified temperature conditions.
3. Identification according to the tests of fire resistance of thermophysical characteristics of the model based on the solution of inverse problems of thermal conductivity.
4. Use of thermophysical characteristics and models to determine the characteristics of fire-retardant ability of coatings of fire-retardant reinforced concrete structures based on fire resistance tests under different test conditions (temperature conditions, fixing conditions, sample loads, temperature measurement scheme) [41].

The above approach can be defined as a set of models, equipment, methods and techniques and as a way (means) to achieve the goal.

### 3.2.1 CHOOSING A METHOD FOR SOLVING INVERSE THERMAL CONDUCTIVITY PROBLEMS

We define inverse and direct problems of thermal conductivity, which are the main types of problems solved in this paper.

According to [202–206], the direct problems of thermal conductivity are the task of finding the distribution of heat and mass potentials  $T$  under known conditions of unambiguity  $P$ , in turn, the inverse problems of thermal conductivity are the task of finding one or more quantities (characteristics, parameters) under conditions of unambiguity, the classification considered in [207] is used to separate the formulations of inverse problems of thermal conductivity.

Before considering methods for solving inverse thermal conductivity problems, let us analyze some symbolic records of direct and inverse thermal conductivity problems. According to the notations adopted in the work, the class of direct problems can be formulated in the following functional form:

$$F(P) = T, \tag{3.14}$$

that is, the operator  $F$  converts the input data  $P$  into the output data  $T$ . The inverse problems in a similar form in general can be represented:

$$F^{-1}(T_e) = P, \tag{3.15}$$

that is, the operator  $F^{-1}$ , reverse operator  $F$ , converts experimental data  $T_e$  in one or another meaning of the required conditions of unambiguity  $P$ .

All known methods for solving inverse thermal conductivity problems can be divided into two groups of methods – direct and extreme. The division of methods into these two groups is based on the use of experimental values of  $T_e$ : or their direct substitution depending on the type (3.15) (when the type  $F^{-1}$  is found), or a substitution in the functional of the  $F$  type:

$$F(P) = \|F(P) - T_e\| \rightarrow \min, \tag{3.16}$$

which is minimized to find the desired values under conditions of unambiguity  $P$  (**Fig. 3.5**). Functional  $F$  in most cases has the form of the sum of squares of deviations of the calculated values from the experimental ones.

It follows that the method of dividing the methods of solving inverse thermal conductivity problems into direct and extreme can be considered the presence in the method of the operation of finding the extremum, the minimum of the mismatch functional [207] or the presence of mathematical transformations to obtain the inverse  $F^{-1}$  operator. In applied mathematics, in particular in linear algebra, the methods of solution are divided into direct and iterative [208]. This division is inherently close to the above.

Direct methods, in turn, can be divided into model behaviour methods and decision behaviour methods [209], depending on how the explicit form of the  $F^{-1}$  operator is obtained: by formally transforming the original mathematical model relative to the desired  $P$  or by transforming analytical or numerical solution of the direct problem with respect to  $R$ .

Extreme methods, in essence, formally satisfy the above requirements of 1–2, so we will dwell on these methods in more detail. It will be recalled that extreme methods look for such values that are included in the conditions of unambiguity  $P$ , which lead to the proximity (in a sense and in a certain norm) of experimental and corresponding to the calculated values of the initial values of the  $T_M$  model.

Functional notation  $F(P)$  implies the need to solve the direct problem of thermal conductivity with the help of appropriate software. Minimization of the functional  $F$  is carried out by various methods from the simplest method of selection (samples) to various iterative computational methods and procedures of gradient and other types [205, 209].

In iterative methods, the extremum  $F$  (usually the minimum) is reached as the limit of successive approximations, which is calculated according to the same scheme.

When choosing and developing a method for solving inverse thermal conductivity problems, we formulate in more detail the requirements for such a method, which are derived from the above analysis:

1. The method should belong to the group of extreme methods for solving inverse thermal conductivity problems. As mentioned earlier, only based on these methods it is impossible to build a method that satisfies the formulated requirements of the approach, because only such methods are invariant to the type of mathematical model and content of the desired characteristics or parameters. In this case, the formulation of the extreme method is universal – to find such values of  $P$  that minimize the value of  $F$ . The functional relationship between the value of  $F$  and  $P$  is always determined by the same dependence, and the relationship between solving direct problems of thermal conductivity  $T_M$  and the required parameters  $P$  – arbitrary operator  $F$ , i.e. functional  $F(P) = \|F(P) - T_e\| \rightarrow \min$ , the same (universal) for finding any values of  $P$  from the conditions of unambiguity. For a mathematical model, algorithm or computer program that simulates the studied heat and mass transfer process and have the functional form  $F(P) = T_M$ , the method, algorithm and computational program for solving the inverse problem based on the implementation of condition (3.13) are also the same for search for any  $R$ . If the form of the operator  $F$  changes, i.e. we turn to the study of other heat and mass transfer processes, the form of  $F(P)$  changes. When using direct methods, it is necessary to change the inverse operator  $F^{-1}$  each time at transition from search of one size from  $P$  to another that does these methods not universal.

The analysis of extreme methods for solving inverse thermal conductivity problems showed that for the general case the most universal are iterative schemes (methods) that allow to obtain solutions of both linear and nonlinear inverse thermal conductivity problems.

2. The method, algorithm and program that implements them are methodologically and programmatically independent of the model and program parts or modules. The values of derivatives of

---

the first  $dT_m/dP$  and higher order can be obtained only numerically on the basis of variation of the required  $P$  and calculation of the corresponding  $T_m$  by solving direct problems of thermal conductivity.

3. The method must include effective procedures (methods) to combat the instability of inverse thermal conductivity problems.

4. The method should be as economical as possible in computational terms. The main criterion for the cost-effectiveness of the method in this regard is the required number of solutions of direct problems of thermal conductivity to obtain the solution of inverse problems of thermal conductivity. This property of the method is especially important for solving common, multidimensional, nonlinear, nonstationary inverse thermal conductivity problems.

5. The method should include procedures for assessing the accuracy of the solution obtained (if the necessary experimental information is available).

The following is a method for solving inverse thermal conductivity problems that satisfies the above requirements.

The iterative Newton-Gaussian method [207] was chosen as a basis for estimating (identifying) parameters in the general case of nonlinear mathematical models (including models of heat and mass transfer processes). As already mentioned [207], the Newton-Gauss method is one of the most effective (in terms of convergence rate) and reliable first-order methods for nonlinear estimation of model parameters. In essence, it belongs to a group of extreme methods for solving inverse thermal conductivity problems, according to which such a vector of required parameters  $P = [P_1, P_2, \dots, P_i, \dots, P_n]$  is calculated, for which the residual value  $F(P)$  seeks to minimize:

$$F(t) = \sum_{j=1}^t [T_{jM}(P) - T_{je}]^2 \rightarrow \min, \quad (3.17)$$

where  $T_{je}$  and  $T_{jM}$  – experimental and model (calculated by solving direct problems of thermal conductivity) values of the potential at the  $j$ -th point, the space-time point of the problem area;  $t$  – the total number of these points.

The point  $j$  means an arbitrary point in space and (or) in time, in which the values of potential or other physical quantity of the studied process are known from the experiment or given in another way, in which the same quantity is calculated using a mathematical model of such process. The numbering of these points in the space-time domain can be arbitrary, chosen for various reasons, the main thing is to maintain their correspondence in the model and the object or process under study.

The following iterative calculation scheme is used to search for the vector  $P$ :

$$P^{l+1} = P^l + \beta^l \cdot \Delta P^l, \quad (3.18)$$

where  $l=0, 1, \dots, L$  – iteration number;  $\beta^l$  – the length of the iterative step;  $\Delta P^l$  – the increment of the vector of the required parameters  $P$  on the iteration  $l+1$ , which is determined by the solution of the following system of linear algebraic equations:





The iterative algorithm (3.18)–(3.23) called the Newton-Gaussian method for estimating the parameters of nonlinear models [207, 211, 212] is part of the group of so-called quasi-Newtonian methods and can be used as one of the most effective methods for solving in the general case of nonlinear inverse problems of thermal conductivity.

Sensitivity functions  $Z_{ji}$ , which are partial derivatives

$$Z_{ji} = \frac{\partial T_{jM}(p)}{\partial p_i}, \quad (3.24)$$

from the potential  $T_{jM}$ , which is calculated by solving direct problems of thermal conductivity at point  $j$  on the  $i$ -th desired parameter  $P_i$ , in the general case are calculated numerically as follows:

$$Z_{ji} = \frac{T_{jM}(p_1, \dots, p_i + \delta p_i, \dots, p_n) - T_{jM}(p_1, \dots, p_i, \dots, p_n)}{\delta p_i}. \quad (3.25)$$

The value of the “perturbation”  $\delta p_i$  or the  $i$ -th required parameter is calculated as  $\beta p_i = 0.001 P_i$ . The value of 0.001 is chosen empirically and allows, on the one hand, to ensure acceptable accuracy of calculation of the value of  $Z_{ji}$  by (3.25), and on the other – to avoid the influence of machine rounding errors.

First of all, it should be noted that the method (3.18)–(3.23), as an iterative extreme method, satisfies the requirements of the universality of the method for solving inverse thermal conductivity problems formulated above. In fact, to implement the algorithm (3.18)–(3.23) it is not necessary to rearrange or modify it in the transition from the search for one parameter to another or from one group of parameters  $P_i$  to another. The use of the numerical method for calculating the sensitivity functions  $Z_{ji}$  also makes the method independent of the structure of the model of direct problems of thermal conductivity. This method of solving inverse thermal conductivity problems is enough to move to a model and program that implements direct thermal conductivity problems as a “black box”, varying the input parameters  $P_i$ , included in the “box”, and using the original calculated values of the “box”  $T_{jM}$ .

Analysis of matrix  $A$  and matrix  $A^T A$  shows that although the  $A^T A$  matrix is positively determined, it is not always positively conditioned. The physical and mathematical incorrectness of the inverse thermal conductivity problems is manifested in the poor conditionality of the  $A^T A$  matrix, so the inversion of the  $A^T A$  matrix (solution of the system of linear algebraic equations (3.19)) can lead to unstable solutions of such a problem.

The following is a method for obtaining a stable solution of the  $A^T A$  matrix by the method of regularization A. Tikhonov [213], according to which instead of a system of equations (3.22) is solved by equation

$$(A^T A + \alpha E) \Delta P = A^T B, \quad (3.26)$$

where  $E$  – single matrix;  $\alpha$  – regularization parameter, which can be selected by various methods described in [203], or by the method of the so-called reference example [200].

There is another way to increase the stability of the solution of the inverse problem of thermal conductivity is a way to narrow the class of required solutions by imposing restrictions on the vector of the required parameters  $P$  above and below. To do this, two more vectors are introduced,  $P_{\max}$  – for the maximum values of the required parameters and  $P_{\min}$  – for minimum. Values  $P_{\max}$  and  $P_{\min}$  are set for various a priori reasons regarding the range of change of the required parameters.

The presence in this algorithm for solving the inverse problem of thermal conductivity of the system of equations (3.19) makes it easy to consider such limitations as follows. Having restrictions on the type of inequalities,

$$\rho_{\min} \leq p_i \leq \rho_{\max}, \quad (3.27)$$

on the iteration of  $l+1$ . For  $q$  parameters included in the vector  $P$  and violated the constraint (3.27), the increase of  $\Delta P_i$  is calculated by the formulas:

$$\Delta p_i = \begin{cases} \rho_{\max} - p_i, & p_i^{l+1} > \rho_{\max} \\ \rho_{\min} - p_i, & p_i^{l+1} < \rho_{\min} \end{cases}. \quad (3.28)$$

The columns of the matrix of the system of equations (3.19) with increments calculated by (3.28) are transferred to the right part of the system of equations, and the matrix (3.27) is solved only for those  $\Delta P_i$ , that did not violate the constraint (3.27). Then the iterative process (3.18)–(3.23) continues in the same way. Naturally, in the presence of  $q$  parameters that violate constraint (3.27), which is solved by a system of linear algebraic equations (3.19), it reduces its order from  $n \times m$  to  $(n-q) \times m$ , i.e., the problem is simplified.

The following methodological approach to the use of procedures 1–4 to combat the instability of solving the inverse problem of thermal conductivity. It is recommended to enter the top and bottom restrictions on the required parameters by always setting the range  $P_{\max}$  and  $P_{\min}$ . If any of the required parameters “falls” in the process of solving the inverse problem of thermal conductivity on any constraint and there is no confidence in the correctness of its setting, this constraint could be “removed”. Constraints are especially useful in solving those inverse problems of thermal conductivity for which it is known a priori that the desired functions or parameters are positive (heat and mass transfer coefficients, sources, heat or mass flows) or negative (effluents, outgoing heat fluxes, or masses).

A. Tikhonov's regularization method is used then, when previous procedures “do not work” and the solution of the inverse problems of thermal conductivity remains unstable. This method can be called “heavy artillery”, the addition of which to the previous procedures allows you to get a stable solution almost always. However, we must pay attention to the choice of the regularization parameter  $\alpha$ .

### 3.3 CHECKING THE EFFICIENCY OF THE PROPOSED CALCULATION AND EXPERIMENTAL METHOD

In this section, work was carried out to identify the relationship between the parameters of fire-retardant plaster coating (on the example of “Neospray”) and fire resistance of fire-retardant multi-hollow reinforced concrete floor as a scientific basis for their use in construction, considering fire safety requirements. experimental method for assessing the fire resistance of fire-retardant reinforced concrete structures. Determination of fire resistance of fire-retardant multi-hollow reinforced concrete floors was carried out in accordance with [214] and consisted in determining the time interval from the start of the test at standard temperature [215] samples of floors under fire on the sample from below before the onset of one of the normalized limit states on the grounds of loss of integrity, load-bearing capacity or thermal insulation capacity.

Two samples of fire-retardant multi-hollow reinforced concrete slabs of PC flooring 48–12–8 with dimensions of 4780×1190 mm and thickness of 220 mm were tested. The plate has a load-bearing steel frame, which consists of five lower longitudinal load-bearing reinforcement 12 mm (reinforcement mark not provided) and 4 mm reinforcement wire Bp1, concrete C12/15. The average value of the thickness of the protective layer of concrete to the lower load-bearing reinforcement was 20 mm. The limit of fire resistance of the plate according to the manufacturer is REI 45. On the samples below and on the sides of the plates with a plaster unit was applied a layer of substance from the fire-retardant coating (plaster) with an average thickness of 25.5 mm. The samples were installed on a horizontal furnace (statically indeterminate support scheme) with support at the edges through compensating supports made of basalt slabs 40 mm thick. The load was carried out by calibrated loads in the form of concrete blocks, which were installed on the samples through compensating supports. The actual load on the samples is set based on the creation in the plates of voltages corresponding to the stresses from a specific distribution load of 570 kg/m<sup>2</sup>.

According to [215], the limiting value of the deflection of the samples, which is 220 mm (deflection  $b=4400$  mm, the estimated thickness of the plates 220 mm), and the limiting value of the rate of deformation – 9.8 mm/min. To measure the average and maximum temperature from the unheated surface of each sample, 5 chromel-alumel thermocouples were installed. One thermocouple in the center of the sample and four in the geometric centers of the quarters of the sample. For tests of the horizontal test furnace and means of measuring equipment which are given in **Table 3.1** were used.

The values of deflection and growth rate of deformation of the samples at 242 minutes of the test were, respectively, 42 mm and 0.4 mm/min (sample № 1) and 46 mm and 0.4 mm/min (sample № 2).

The results of measurements of temperature values in the fire furnace are shown in **Fig. 3.6**, and from the unheated surface of the fire-retardant reinforced concrete floor slab – in **Fig. 3.7**.

The data obtained as a result of tests for fire resistance (**Fig. 3.6, 3.7**), later, according to the mathematical model and the proposed method, were used to determine the thermophysical characteristics of the coating under study [196].

**Table 3.1** Means of measuring equipment

Nº	The name of the equipment	Serial number	Measuring range	Measurement error
1	Metal ruler	–	from 0 to 1000 mm	$\pm 1$ mm
2	Metal roulette	–	from 0 to 5000 mm	$\pm 1$ mm
3	Stopwatch	8826	from 0 to 60 s from 0 to 60 min	$\pm 0.4$ s $\pm 1$ s
4	The device of control of excess pressure in the TNZh-N furnace	24723	from 0 to 100 Pa	1.5
5	Thermocouples THA, 16 units	–	from 0 to 334 °C from 334 to 1300 °C	$\pm 2.5$ °C $\pm 0.0075 \times T$ measer., °C
6	Psychrometer aspiration MV-4M	18358	from 10 to 100 % from -25 to 50 °C	$\pm 3$ % $\pm 0.2$ °C
7	Calipers	B205755	from 0 to 250 mm	0.05 mm
8	Measuring and recording complex "TEST-SERT"	1	from 0 to 1300 °C	$\pm (0.5 + 0.0009T)$ °C $\pm 1$ c

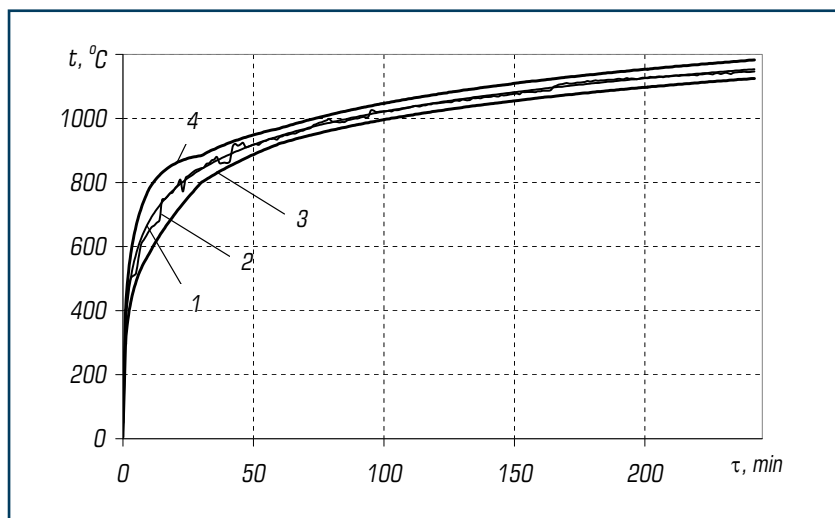

**Fig. 3.6** Dependence of the temperature in the furnace on the time of fire exposure on the heating surface of the fire-retardant reinforced concrete multi-hollow slab with a thickness of 220 mm: 1 – curve of standard temperature regime; 2 – real curve of temperature change in the furnace; 3 – the minimum values of temperature in the furnace are admissible at tests; 4 – the maximum values of temperature in the furnace are admissible at tests

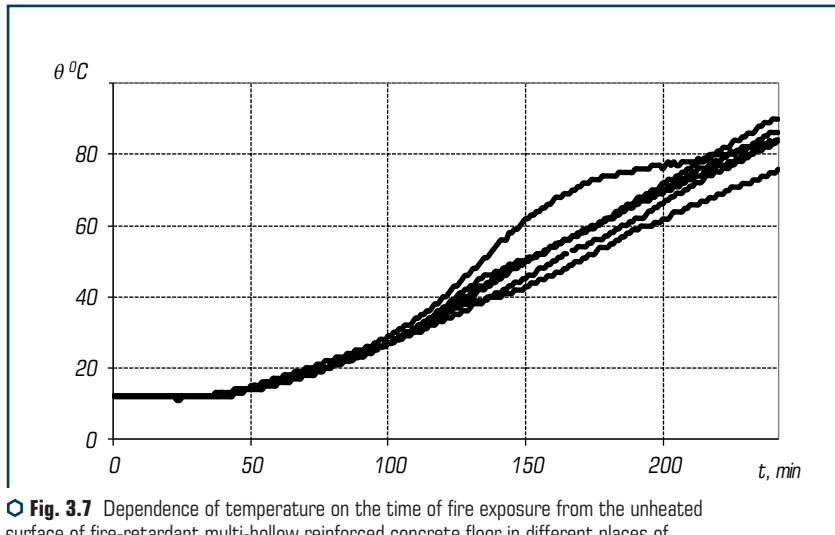

○ Fig. 3.7 Dependence of temperature on the time of fire exposure from the unheated surface of fire-retardant multi-hollow reinforced concrete floor in different places of temperature measurement

To do this, we chose a one-dimensional mathematical model of the thermal state of fire-retardant reinforced concrete floor with 6-layer slab, which is a one-dimensional equation of thermal conductivity considering radiant heat transfer and boundary conditions of the third kind on the heating surface and boundary conditions of the third kind.

The FRIEND-2 software package was used to determine the thermophysical characteristics of fire-retardant coatings of steel and reinforced concrete structures, as well as other parameters of heat exchange processes based on non-stationary measurements of temperatures inside or on the surface of samples, heat fluxes, temperature values or heat transfer coefficients.

To determine the required thickness of the investigated fire-retardant coating of reinforced concrete structures, the thermophysical characteristics of concrete (**Fig. 3.8**) of fire-retardant flooring were first found by solving inverse thermal conductivity problems, which are most effectively solved on the basis of one-dimensional 1D models. For this purpose, a 1D equivalent model of the thermal state of the structure in the FRIEND software environment was used [216, 217].

Using the found dependences (**Fig. 3.8**) further calculations on definition of thermophysical characteristics of plaster structure (**Fig. 3.9**) which depend on temperature were carried out. Although, according to the manufacturer, the coefficient of thermal conductivity of the investigated coating in the dry state is equal to 0.11 W/m·°C at 20 °C. However, it is clear that for most fire-retardant materials the thermophysical characteristics of the temperature change during heating due to physico-chemical processes in them [218].

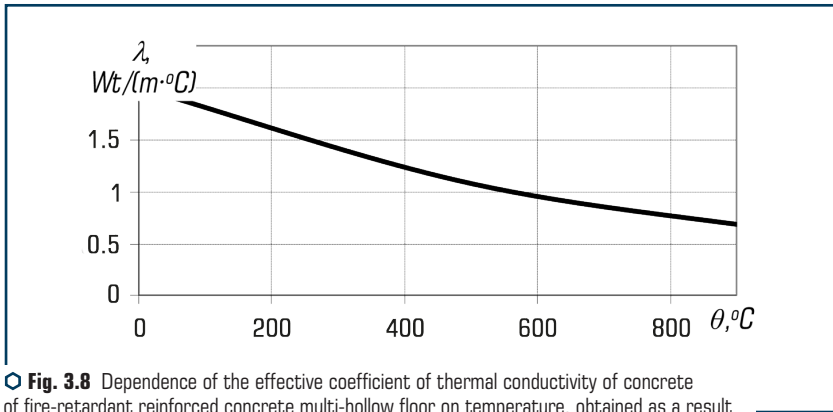

○ **Fig. 3.8** Dependence of the effective coefficient of thermal conductivity of concrete of fire-retardant reinforced concrete multi-hollow floor on temperature, obtained as a result of solving the inverse problems of thermal conductivity according to fire resistance tests

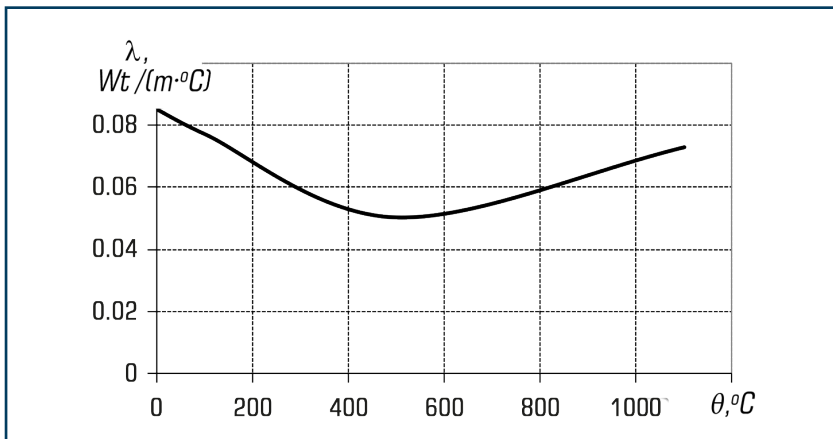

○ **Fig. 3.9** Dependence of the effective coefficient of thermal conductivity of plaster coating on the temperature found by solving the inverse problems of thermal conductivity according to the tests of fire resistance of fire-resistant multi-hollow reinforced concrete floor

As can be seen from **Fig. 3.9**, in the temperature range from 0 °C to about 500 °C the value of the thermal conductivity of the investigated plaster coating decreases linearly and passes through a minimum value of 0.05 W/m·°C (at 500 °C), which can be explained by a decrease in density and increasing the porosity of the coating by removing natural and chemically bound moisture. The increase in the thermal conductivity in the temperature range from 500 °C to 1100 °C is due

to the appearance of the radiation component in the pores of the coating in combination with its high-temperature shrinkage.

Criterion (3.13) was  $0.827\text{ }^{\circ}\text{C}$ , and the calculated and experimental temperatures are shown in **Fig. 3.10**.

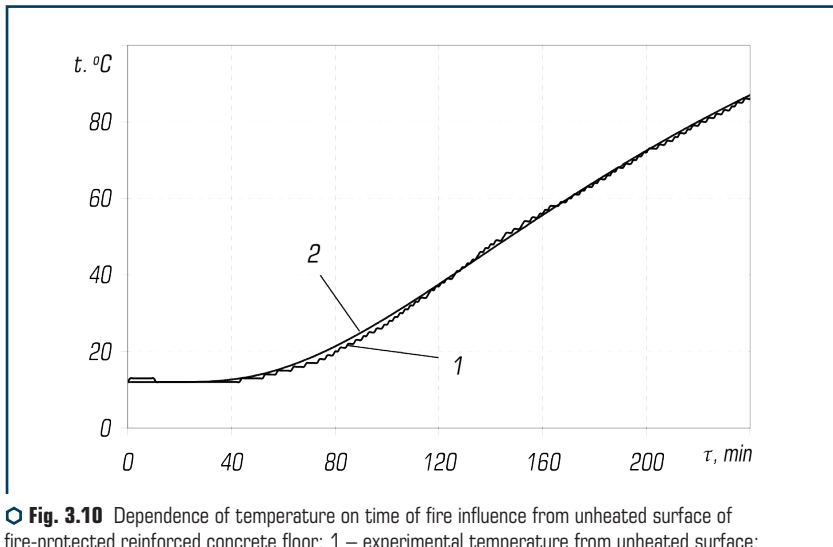

**Fig. 3.10** Dependence of temperature on time of fire influence from unheated surface of fire-protected reinforced concrete floor: 1 – experimental temperature from unheated surface; 2 – design temperature obtained by solving the inverse problems of thermal conductivity

When finding the thermophysical characteristics of the coating, the specific volumetric heat capacity of the plaster coating was set constant and equal  $C_v=1\cdot106\text{ J/m}^3\cdot^{\circ}\text{C}$ , and the thermal conductivity coefficient was calculated as a function of temperature. Thermophysical characteristics of concrete layers were used previously found (**Fig. 3.8**).

To assess and predict the fire resistance of fire-retardant multi-hollow reinforced concrete floors, it is necessary to know at what thickness of the fire-resistant plaster coating provides the normalized limit of fire resistance of this floor. For this purpose, the characteristics found above are used: thermophysical characteristics of concrete (**Fig. 3.8**) and plaster coating (**Fig. 3.9**).

This dependence in this work is called the characteristic of fire-retardant ability of the coating and is defined as the dependence of the thickness of the fire-retardant coating on the thickness of the protective layer of concrete (distance between the heating surface and adjacent reinforcement). the ability or achievement of critical temperature reinforcement at a specified load level in the test [219]. Based on the developed method of assessing the fire resistance of fire-retardant reinforced concrete structures by solving a series of direct problems of thermal conductivity,

the dependence was found for the normalized values of fire resistance of fire-resistant multi-hollow reinforced concrete floors (**Fig. 3.11**).

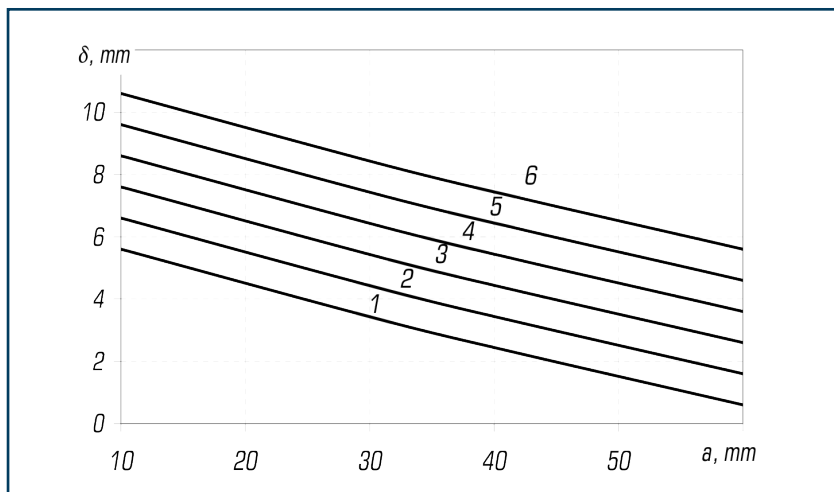

**Fig. 3.11** Dependence of the thickness ( $\delta$ ) of "Neospray" plaster coating on the thickness of the protective layer of concrete of multi-hollow reinforced concrete floor ( $a$ ) according to the criterion of reaching the critical temperature of reinforcement ( $500\text{ }^{\circ}\text{C}$ ) for fire resistance: 1 – 60 minutes; 2 – 90 minutes; 3 – 120 minutes; 4 – 150 minutes; 5 – 180 minutes; 6 – 240 minutes

With the help of the obtained dependence, it is possible to determine the thickness of the fire-retardant plaster coating depending on the thickness of the protective layer of concrete for the required limit of fire resistance of the fire-retardant reinforced concrete structure, at which there is a limit state of the structure of fire resistance on the basis of reaching the critical temperature of the valve at a given level of load or thermal insulation capacity [220].

It should be noted that the accuracy of fire-retardant performance is estimated at 16 % and may be higher if additional temperature measurements are used not only from the unheated surface, but also on the fittings, under the fire-retardant coating and in the middle of the floor [221].

Thus, the study of the relationship between the parameters of fire-retardant plaster coating (on the example of "Neospray") and fire resistance of fire-retardant multi-hollow reinforced concrete floor in general confirmed the effectiveness of the calculated and experimental method for assessing fire resistance of fire-retardant iron-resistant structures. The advantage of the proposed method is the ability to assess the fire resistance of fire-retardant and unprotected reinforced concrete structures and the fire-retardant ability of coatings. This method is more economical than experimental or computational, which allows the results of one or more



experiments (fire tests), using the developed mathematical models, to assess the fire resistance of structures and fire resistance of coatings. These results will allow a more accurate approach to assessing the fire resistance of such structures with fire protection in the design of buildings and structures. The results of the study will be useful for designers, manufacturers of fire retardants, as they allow to calculate the required thickness of coatings, which provides a normalized limit of fire resistance at a given thickness of the protective layer of concrete structures of buildings and structures.

### **CONCLUSIONS ON THE SECTION 3**

1. Physical and mathematical models for assessing the fire resistance of fire-retardant reinforced concrete structures have been developed. An algorithm was applied, which includes the following stages: selection of the formalization apparatus, construction of the external description, verification of the model's operability, construction of the internal state, verification of operability and identification of parameters. The initial and boundary conditions for the construction of these models are formulated, which allow to predict the fire resistance of the fire-resistant reinforced concrete structure with sufficient accuracy for engineering calculations. The peculiarity of the developed models is taking into account the thermophysical characteristics of reinforced concrete structures and fire-retardant coatings, as well as taking into account the peculiarities of the formation of fire regimes.

2. Based on the offered physical and mathematical models the calculation-experimental method of estimation of fire resistance of fire-protected reinforced concrete designs is developed. The structural-logical scheme of realization of the developed method provides 9 blocks located in 5 levels connected by logical connections and includes experimental and computational parts. The experimental part of the method involves a series of tests for fire resistance at specified fire conditions (standard, external, hydrocarbon, tunnel, real fire). Calculation part – contains the following mandatory procedures: construction of a calculation model of the physical process; identification according to the data on fire resistance tests of thermophysical characteristics of the model based on the solution of inverse problems of thermal conductivity; determination of characteristics of fire-retardant ability of coatings based on the results of tests for fire resistance of fire-retardant reinforced concrete structures under different test conditions (fire conditions, fixing conditions, load of samples, temperature measurement scheme, climatic factors).

3. The efficiency of the developed calculation and experimental method for assessing the fire resistance of fire-retardant reinforced concrete structures by identifying the relationship between the parameters of fire-retardant plaster coating (on the example of “Neospray”) and fire resistance of fire-resistant multi-hollow reinforced concrete floor. This created a scientific basis for the use in the construction of fire-retardant reinforced concrete structures, taking into account the requirements of fire and man-made safety. The dependence of the thickness of the plaster composition “Neospray” on the thickness of the protective layer of concrete of fire-retardant reinforced

concrete multi-hollow floor for the normalized limit of fire resistance of the floor 60–240 minutes. The efficiency of the investigated plaster fire-retardant coating is proved and the dependence of the thermal conductivity coefficient on the temperature under heating conditions in the test furnace of fire-retardant multi-hollow reinforced concrete floor at standard fire temperature is established. It was found that in the temperature range from 0 °C to 500 °C the value of the thermal conductivity of the plaster coating “Neospray” decreases and passes through a minimum value of 0.05 W/m·°C (at 500 °C), due to reduced density and increasing the porosity of the coating by removing natural and chemically bound moisture. The increase in the thermal conductivity in the temperature range from 500 °C to 1100 °C, due to the appearance of the radiation component in the pores of the coating in combination with its high-temperature shrinkage.

ABSTRACT

---

In this section the mathematical model and method of estimation of fire resistance of fire-protected steel designs is developed, the algorithm of application of the developed method is considered, the description of procedures of its realization is given. The efficiency of the proposed method in determining the influence of climatic factors of fire temperature (on the example of the temperature of a hydrocarbon fire) on the accuracy of assessing the fire resistance of fire-resistant steel structures.

---

## KEYWORDS

Fire-retardant steel structure, fire-retardant coating, fire temperature regimes, inverse problem of thermal conductivity, thermophysical characteristics, evaluation of fire resistance of fire-retardant steel structures.

#### 4.1 MATHEMATICAL MODEL FOR ESTIMATING THE FIRE RESISTANCE OF A FIRE-RESISTANT STEEL STRUCTURE

Mathematical model for assessing the fire resistance of fire-retardant steel structure includes the following factors: temperature of the fire, thermophysical characteristics of the protected surface and fire-retardant coatings, climatic factors [222].

The physical model of thermal conductivity in the system “steel structure – fire-retardant coating” is the heating of a two-layer plate consisting of a layer of steel with a thickness of  $d_s/2 = V/A_p$  and a layer of fire-retardant coating with a thickness of  $d_p$  (Fig. 4.1). On the  $x_2$  side of the coating, convective-radiation heating from hot gases in a fire furnace is carried out. In the considered physical model of heating of a two-layer plate only half of a layer of metal ( $d_s/2$ ), is considered as in the conditions of tests on fire resistance, as a rule, bilateral heating of a steel sample is carried out. As a result, at the limit  $x=0$  (Fig. 4.1) the condition of symmetry of the temperature curve is accepted, which is equivalent to the absence of heat flow on the left.

As is known, the nonlinear mathematical model of the thermal conductivity process in such a two-layer plate for the Cartesian coordinate system is a one-dimensional equation of thermal conductivity with boundary conditions of the 3rd kind on the boundary  $x=x_2=d_s/2+d_p$  and zero heat flux on the boundary  $x=0$ . The temperature distribution  $\theta$  in the sample and the coating is described by the system of equations [223]:

---

$$C_i(x,t) \frac{\partial T}{\partial t} = \frac{\partial}{\partial x} \left( \lambda(x,T) \frac{\partial T}{\partial x} \right), \quad (4.1)$$

$$0 < x < x_2; \quad T = T(x, t),$$

$$\text{– initial condition: } \theta_p(x,0) = \theta_0, \quad (4.2)$$

– boundary condition on the heating surface of the coating, when  $x = d_p$  :

$$\lambda_c \frac{\partial T(x_2, t)}{\partial x} + \alpha^* (T_s(t) - T(x, t)) = 0, \quad (4.3)$$

$$\alpha^* = \alpha_c + F \cdot \varepsilon_f \cdot \sigma \left[ (\theta_{g,t} + 273)^4 - (\theta_m + 273)^4 \right] / (\theta_{g,t} - \theta_m), \quad (4.4)$$

where

– boundary condition on the inner surface of the coating, when  $x=0$ :

$$\lambda_p \frac{\partial Q_p}{\partial x} = C_a \cdot \rho \frac{V}{A_p} \cdot \frac{\partial Q_p}{\partial t}, \quad (4.5)$$

$$\theta_a(t) = \theta_p(0,t), \quad (4.6)$$

where  $x$  – coordinate in the coating ( $x=0$  corresponds to the point of contact of the coating with the steel surface),  $m$ ;  $t$  – time,  $s$ ;  $t_{fi,requ}$  – time that corresponds to the normalized limit of fire resistance;  $\alpha_c$  – convection heat transfer coefficient on the heating surface of the coating, for standard temperature  $\alpha_c=25 \text{ W/(m}^2 \cdot \text{°C)}$ , for the temperature of the hydrocarbon fire  $\alpha_c=50 \text{ W/(m}^2 \cdot \text{°C)}$ ;  $\alpha^*$  – total heat transfer coefficient by convection and thermal radiation on the heating surface of the coating;  $F$  – angular coefficient,  $F=1.0$ ;  $\varepsilon_m$  – coefficient of thermal radiation of the heating surface of the coating,  $\varepsilon_m=0.8$ ;  $\varepsilon_f$  – coefficient of thermal radiation of the flame,  $\varepsilon_f=1.0$ ;  $\sigma$  – Stefan–Boltzmann constant,  $\sigma=5.67 \cdot 10^{-8} \text{ W/(m}^2 \cdot \text{°C}^4)$ ;  $\theta_a$  – steel temperature, °C;  $\theta_{g,t}$  – the temperature of the gaseous medium at time  $t$ , which varies according to the set temperature of the fire, °C;  $\theta_m$  – the temperature of the heating surface of the coating, °C;  $\theta_0$  – initial temperature,  $\theta_0=20 \text{ °C}$ ;  $\theta_p$  – coating temperature, °C;  $\theta_p$  – thermal conductivity of the coating,  $\text{W/(m} \cdot \text{°C)}$ ;  $c_a$  – specific heat capacity of steel,  $\text{J/(kg} \cdot \text{°C)}$ ;  $c_p$  – specific heat capacity of the coating,  $\text{J/(kg} \cdot \text{°C)}$ ;  $c_p$  – coating density,  $c_p=1420 \text{ kg/m}^3$  (manufacturer data);  $c_a$  – density of steel,  $c_a=7850 \text{ kg/m}^3$ ;  $A_p/V$  – the coefficient of cross section of the protected steel structure,  $\text{m}^{-1}$ .

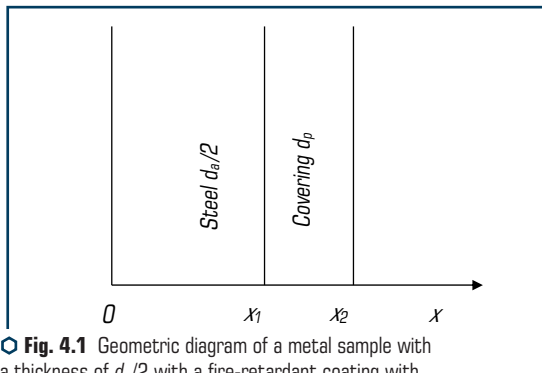

Fig. 4.1 Geometric diagram of a metal sample with a thickness of  $d_s/2$  with a fire-retardant coating with a thickness of  $d_p$

The analytical-numerical solution of such a model with respect to the temperature on a steel structure is the expression

$$\Delta\theta_{a,t} = \frac{\lambda_p A_p / V(\theta_{g,t} - \theta_{a,t})}{d_p c_p \rho_p (1 + \varphi / 3)} \Delta t - (e^{\varphi/10} - 1)\Delta\theta_{g,t}, \quad (4.7)$$

when  $\Delta\theta_{a,t} \geq 0$ , if  $\Delta\theta_{g,t} > 0$ , a  $\varphi = \frac{c_p \rho_p}{c_a \rho_a} d_p A_p / V$ .

Condition (4.5) takes into account the heat capacity of the steel layer, the absence of a spatial temperature gradient in the steel structure and geometrically the steel layer  $d_s/2$  in the area of solving the problem (Fig. 4.1). Thus, equation (4.5) at the inner boundary of the coating  $x=x_1$  describes the heating of a steel layer of volume  $V$  and thickness  $d_s/2$  from the heat flux coming from the inner surface of the coating. It is considered that condition (4.5) is valid, because the coefficient of thermal conductivity of the steel structure is much higher than the coefficient of thermal conductivity of the fire-retardant coating.

Given the formal geometric absence of a metal layer in the solution area, for ease of presentation, move point  $x_1$  (Fig. 4.1) in the point  $x=0$ , and point  $x_2$  – in the point  $x_1$ , which is equal to the thickness of the coating layer  $d_p$ .

The numerical solution of the system of equations (4.1), (4.3)–(4.5) is quite simply realized by using the finite difference method (explicit four-point approximation scheme) on the calculated grid  $k=1, 2, \dots, K$  with spatial coordinates  $x_k = \Delta x \cdot (k-1)$ ,  $\Delta x = d_p / (K-1)$ .

According to this scheme, for the point  $k=1$  and the corresponding coordinate  $x_1=0$ , which is located on the border of steel – fire-retardant coating, the temperature  $\theta_p(0)$  at time  $t + \Delta t$  is determined by the expression:

$$\theta_{\rho,t+\Delta t}(0) = \theta_{\rho,t}(0) + \Delta F_0 \left[ \theta_{\rho,t}(x_2) - \theta_{\rho,t}(0) \right] / \left[ c_p \rho_p V \Delta F_0 \Delta x / (\lambda_p A_p \Delta t) + 0,5 \right]. \quad (4.8)$$

Temperature  $\theta_{\rho,t+\Delta t}(x_k)$  at a moment of time  $t+\Delta t$  at the inner points of the fire protection coating  $k=K-1, K-2, \dots, 2$  and the corresponding coordinates  $x_k=\Delta x \cdot (k-1)$  is defined by the expression:

$$\theta_{\rho,t+\Delta t}(x_k) = \theta_{\rho,t}(x_k) + \Delta F_0 \left[ \theta_{\rho,t}(x_{k+1}) - 2\theta_{\rho,t}(x_k) + \theta_{\rho,t}(x_{k-1}) \right]. \quad (4.9)$$

Temperature  $\theta_{\rho,t+\Delta t}(d_p)$  at a moment of time  $t+\Delta t$  at the point  $k=K$  with the coordinate  $x_k=d_p$ , located on the surface of the fire-retardant coating, is determined by the expression

$$\theta_{\rho,t+\Delta t}(d_p) = \theta_{\rho,t}(d_p) - 2\Delta F_0 \left[ \theta_{\rho,t}(d_p) - \theta_{\rho,t}(d_p - \Delta x) \right] + \frac{2\alpha_t^* \Delta F_0 \Delta x}{\lambda_p} \left[ \theta_t - \theta_{\rho,t}(d_p) \right], \quad (4.10)$$

where  $\Delta F_0 = \frac{\lambda_p \Delta t}{c_p \rho_p \Delta x^2}$ , and the value of  $K > 20$ . To ensure the numerical stability of the

calculations, the time increment  $\Delta t$  should be chosen taking into account the condition  $\Delta F_0 < 0.5$ .

According to the measurements of temperature  $\theta_a(0)$  when testing samples of steel structures and calculated temperatures  $\theta_p(0)$  are found with the method of least squares such values  $\lambda_p$  and  $c_p$ , for which the value of the standard deviation  $F$  of the calculated  $\theta_p(0)$  and experimental  $\theta_a(0)$  values of temperatures on the steel wall at the point  $x=0$  will be the minimum for all samples tested:

$$F = \sqrt{\frac{\sum_{j=1}^m \sum_{i=1}^n \left[ \theta_p^{i,j}(0,t) - \theta_a^{i,j} \right]^2}{\sum_{j=1}^m n_j}}, \quad (4.11)$$

where  $j=1, 2, \dots, m$ ;  $j$  – the number of the sample under test;  $m$  – total number of samples;  $n_j$  – the number of experimental temperature values  $\theta_a^{i,j}$ , used in formula (4.11), for each sample with number  $j$  ( $j=1, 2, \dots, m$ ).

The calculated temperature values are determined from the solution of equations (4.6)–(4.11) for each of the columns numbered  $j$ . This decision is carried out by numerical method.

To determine the dependences of the thermal conductivity coefficient  $\lambda_p$  and the specific heat capacity  $c_p \rho_p$  of the flame retardant coating on temperature, it is recommended to use the method of solving the inverse thermal conductivity problem based on the Newton–Gauss iterative method of finding the minimum of the function  $F$  and the A. Tikhonov regularization method, the following algorithm is recommended, which allows to obtain optimal solutions of the inverse thermal conductivity problem.

When solving the inverse problem of thermal conductivity, this method considers the spline approximation of the thermophysical characteristics of the fire-retardant coating of zero, first and third orders (zero order – constant values, first – linear dependence, third – cubic spline).

In the first step, the search for  $\lambda_p$  and  $c_p \rho_p$  of fire-retardant coatings as constants of constants (constants) is performed. The values of the found constants are used as a zero approximation for the next step, in which the search for  $c_p \rho_p$  as a constant is performed, and for  $\lambda_p$  a first-order spline approximation with two temperature nodes is used. The obtained solution is used as a zero approximation for the third step, in which  $c_p \rho_p$  is searched as a constant, and for  $\lambda_p$  the same spline approximation is used, but with three nodal points in temperature. The increase in the number of nodal points for this spline approximation  $\lambda_p$  is performed until the step in which the decrease in the deviation  $F$  stops.

In the following steps, a first-order spline approximation is used for specific heat consumption capacity  $c_p \rho_p$  and the same procedure for determining the number of nodes of its spline approximation as for  $\lambda_p$ .

In the future, if necessary, use a spline approximation of thermophysical characteristics of the third order. The solution of the inverse problems of thermal conductivity is stopped if a further increase in the number of nodal points in the temperature for spline approximation of the thermophysical characteristics of the fire-retardant coating does not lead to a decrease in the deviation  $F$ . Decisions with the lowest deviation value  $F$  are taken as optimal.

Using the found temperature dependences  $\lambda_p(\theta_p)$  and  $c_p \rho_p(\theta_p)$  (or constant value of specific volume heat capacity), the fulfillment of the acceptance criteria is checked. If these criteria are not met, then modify the values of the coefficient of thermal conductivity at nodal points in temperature. The modified values of the thermal conductivity of the flame retardant coating ( $\lambda_{\text{mod}(p)}$ ) at each node point are calculated by formula (4.8). This determines the value of the modification coefficient  $K$ , which leads to the fact that the calculated values of the time to reach the critical temperature meet the acceptance criteria and are closest to the experimental values of this time:

$$\lambda_{\text{mod}(p)} = K \lambda_p. \quad (4.12)$$

The dependences  $\lambda_p(\theta_p)$  (modified, if necessary) and  $c_p \rho_p(\theta_p)$  (or constant value of specific heat) are used for further calculations of the values of the minimum thickness of the flame retardant coating. In this case, the values of this thickness are determined by multiple solutions of the direct problem of thermal conductivity using the mathematical model (4.1)–(4.6). It is expedient to carry out this decision by the method of finite differences according to the implicit scheme of approximation with the help of the developed physical model of the system “steel structure – fire-retardant coating” (**Fig. 4.2**).

These physical and mathematical models take into account the fact that the heating surface of the fire-retardant coating is heated by convective radiation from hot gases in a furnace with a temperature of  $\theta_{g,t}$ . Inside the system “fire-retardant coating – steel plate – insulation” heat is

transferred by thermal conductivity. The condition of ideal thermal contact between the layers of the system is accepted. From the unheated surface of thermal insulation heat exchange occurs by convection [224].

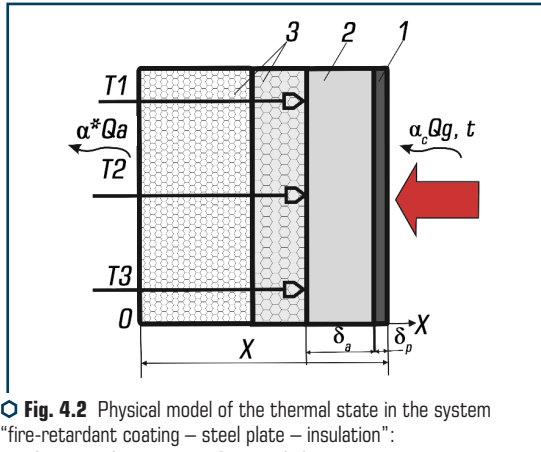

○ **Fig. 4.2** Physical model of the thermal state in the system "fire-retardant coating – steel plate – insulation":  
 1 – fire-retardant coating; 2 – steel plate;  
 3 – 2 layers of heat-insulating material

#### 4.2 DEVELOPMENT OF A STRUCTURAL-LOGICAL SCHEME OF THE COMPUTATIONAL-EXPERIMENTAL METHOD

The developed calculation and experimental method for assessing the fire resistance of fire-resistant steel structures involves the following steps (**Fig. 4.3**):

1. Tests for fire resistance of fire-resistant steel structures or experiments to determine the temperature of the unheated surface of reduced samples of fire-resistant steel structures under certain test conditions (fire temperatures: standard, hydrocarbon, external, tunnel, real) depending on the operating conditions of fire protection [225].

2. Construction of mathematical, physical, geometric and computer models of processes occurring in the studied fire-retardant steel structure when tested for fire resistance under certain test conditions [226].

3. Based on the data obtained as a result of tests for fire resistance (temperature in the furnace, temperature on the samples of the tested structure), the thermophysical characteristics of fire-retardant coating (thermal conductivity coefficient, specific volume heat capacity) are determined by solving the inverse thermal conductivity problem [227].



4. Determining the characteristics of fire-retardant ability of fire-retardant coating – the dependence of the minimum thickness of the coating on the thickness of the steel structure, the duration of fire and the value of critical steel temperature, by solving direct problems of thermal conductivity [228].

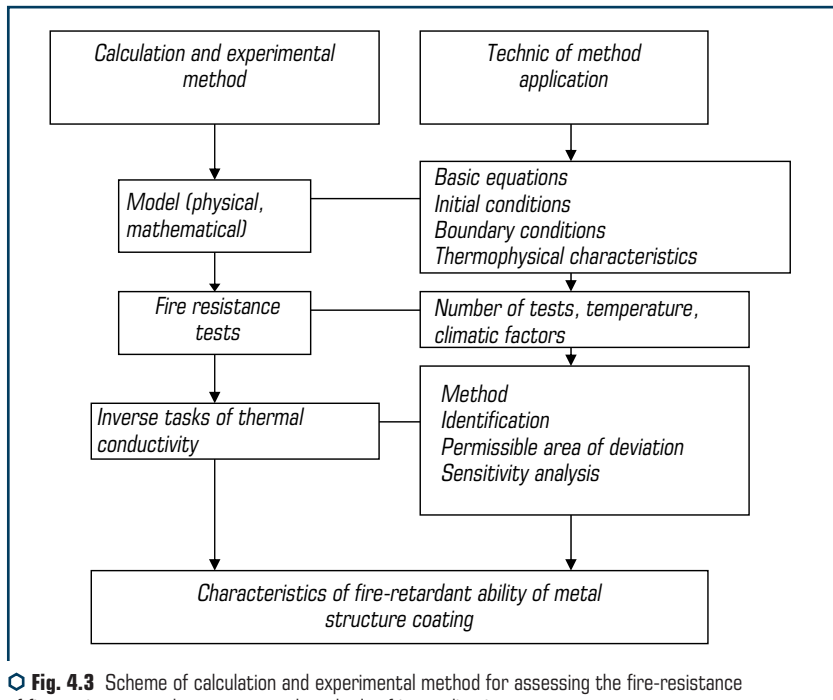

**Fig. 4.3** Scheme of calculation and experimental method for assessing the fire-resistance of fire-resistant steel structures and methods of its application

The difference between the developed calculation and experimental method from existing methods is that the developed method is a more universal and accurate method compared to experimental or calculation methods. It allows the results of one or more tests for fire resistance (experimental part of the method), using the developed mathematical, computer, numerical models (calculation part of the method) to study the physical processes occurring in fire-resistant steel structures. Thus, by means of the developed method it is possible to consider various factors influencing fire-resistant steel designs: temperature modes of fire at which there is a test for fire resistance; climatic factors that affect the limit of fire resistance of structures; thermophysical characteristics of steel structures and coatings for fire protection of steel structures; adhesion of fire-retardant coatings to the protected surface.

### 4.3 THE PROCEDURE FOR IMPLEMENTING THE CALCULATION AND EXPERIMENTAL METHOD

#### 4.3.1 DETERMINATION OF THE INFLUENCE OF CLIMATIC FACTORS AND TEMPERATURE OF THE FIRE

The issues of determining the predicted shelf life of coatings of fire-retardant steel structures by the method of accelerated tests and experimental determination of fire-retardant ability of coatings of steel structures after climatic tests (for example, water-repellent coating based on "Phoenix STS"). The list of problematic issues that occur in determining the fire-retardant ability of coatings of steel structures after their climatic tests is highlighted. The method of the research of fire-retardant ability of coverings of steel designs after influence of climatic factors is offered.

To consider the influence of climatic factors on the fire-retardant ability of fire-retardant coatings, it is proposed to use a technique that includes experimental and computational operations, the sequence of which corresponds to the structural-logical scheme presented in **Fig. 4.4**.

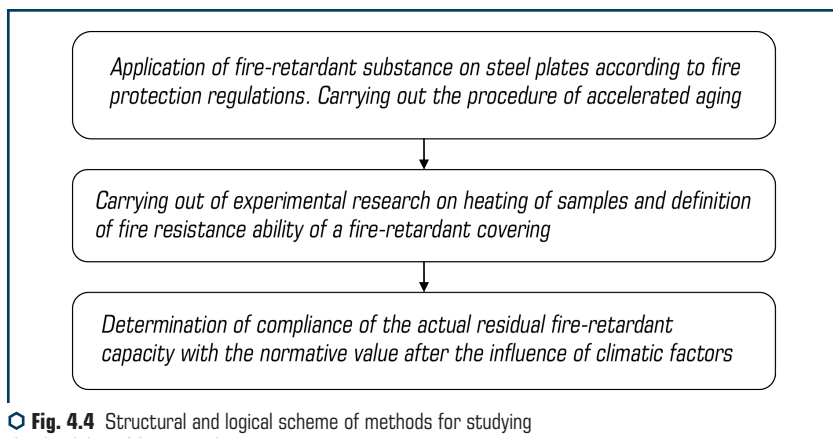

**Fig. 4.4** Structural and logical scheme of methods for studying the durability of fire-retardant coatings

The essence of the proposed technique is to determine the fire-retardant effectiveness of fire-retardant coatings that have been affected by climatic factors, followed by their comparison with the corresponding values of fire-retardant coatings that have not been affected.

Determination of the durability of fire-retardant coatings is proposed to be carried out in 2 stages [229–231]. At the first stage it is necessary to obtain outdated samples of fire-retardant coatings. The second is to determine the residual fire-retardant ability of the coating and compare it with the normative values to determine the effectiveness.

To obtain outdated samples of fire-retardant coatings, two methods are used: the method of field tests of fire-retardant coatings (aging occurs under the influence of the environment) and the method of predicting the shelf life of fire-retardant coatings based on accelerated climatic tests. The essence of the accelerated tests is to create in the climate chamber a cyclical effect of the annual number of climatic factors of a given region. Existing methods provide for a different number of accelerated climate cycles, which correspond to 1 year of real influence of climatic factors.

Due to the fact that every year in Ukraine new manufacturers of fire protection products appear on the market, which offer fundamentally new approaches to fire protection, as well as the life cycle of most fire-retardant coatings is less than the warranty period of their fire-retardant properties, it becomes obvious that preference should be given to methods for predicting the durability of fire-retardant coatings based on accelerated climate tests. Existing approaches to determining the fire-retardant ability of obsolete coatings consider a large number of indicators, although some of them do not even relate to fire-retardant properties. However, most researchers tend to consider the main criterion that characterizes the preservation of normative fire-retardant properties – is the compliance of their actual fire-retardant ability to normative values.

To study the influence of climatic factors on the fire-retardant coating, fire tests of fire-retardant steel structures were performed using samples of reduced size. Prepared 4 steel plates made of steel St3 (**Fig. 4.5, a**), size 500×500 mm and thickness 5 mm with a flame retardant applied to one surface of the plate (**Fig. 4.5, b**). A layer of soil GF-021, 0.065 mm thick, was applied from the heating surface of the steel plate before applying the flame retardant.



The flame retardant was applied according to the manufacturer's technology by a mechanized method with an airless spray unit on a specific surface in compliance with all requirements (**Fig. 4.5, b**) [216, 232]. Two of the four steel plates were control and were not exposed to climatic factors.

To measure the thickness of the formed fire-retardant coating used a thickness gauge, which was measured at 9 points, the average thickness was 0.31 mm.

At the first stage, accelerated artificial aging of steel plates with a fire-retardant coating in the climate chamber was carried out. The second stage consisted of fire tests of steel plates with aged coating and comparison of data with control samples. The essence of climatic tests is the cyclic reproduction of temperature and humidity in the chamber according to the appropriate method [216], during which there are eight repetitions of this cycle, which corresponds to 1 year of service life of fire-retardant coating in real climatic conditions.

According to the chosen method of accelerated aging, the mode was selected that corresponds to the room that is not heated:

- 1) temperature  $(40 \pm 2)$  °C, relative humidity  $(90 \pm 3)$  % for 6 hours;
- 2) temperature  $(20 \pm 2)$  °C, relative humidity  $(90 \pm 3)$  % for 2 hours;
- 3) temperature  $(-15 \pm 3)$  °C, relative humidity not more than 80 % within 3 hours;
- 4) temperature  $(60 \pm 2)$  °C, relative humidity not more than 80 % within 7 hours;
- 5) temperature  $(20 \pm 2)$  °C, relative humidity not more than 80 % for 6 hours.

Eight repetitions of this cycle correspond to 1 year of service of a fire-retardant covering in real conditions. As a result of the accelerated aging procedure, samples were obtained that are aged for 1 and 3 years, respectively. In the course of accelerated aging, there was no significant “washing away” of the fire-retardant coating from the surface of the steel plate.

The next step was to conduct fire tests of coated steel plates after exposure in a climate chamber and compare the data with control samples according to the method [232].

To measure the temperature from the unheated surface of the steel plate, 3 thermocouples of the THA type (**Fig. 4.6**) with a wire diameter of 0.5 mm (T1–T3), one thermocouple (T2) in the center of the sample and two (T1, T3) at a distance of 100 mm from the edges of the plate. Thermocouple joints are hammered into the metal to a depth of 2 mm and attached with heat-insulating material.



○ **Fig. 4.6** Layout of thermocouples from the unheated surface of the steel plate before the test

From the unheated surface the plate was protected by two layers of mullite silica felt, 20 mm thick, and a plate of mineral wool, density 75 kg/m<sup>3</sup> and thickness 50 mm (**Fig. 4.7**).



**Fig. 4.7** View of the sample from the unheated surface of the steel plate

The tests were performed at an air temperature of 15.8 °C, a relative humidity of 48 % and a pressure of 743 mm Hg.

The essence of the test was to create a temperature in the furnace, close to the standard temperature of the fire by burning liquid fuel (**Fig. 4.8**). After the start of the test and until its end, the excess pressure in the furnace was 10 PA. During the test, the test specimen was subjected to thermal action, and the time from the beginning of such action to reach a temperature of 550 °C from the unheated surface of the steel plate was determined.

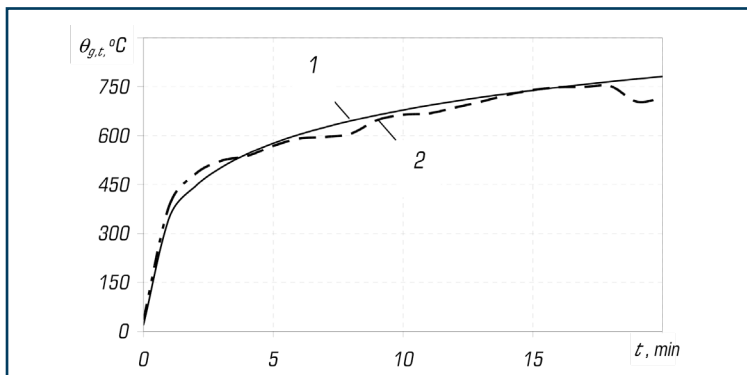

**Fig. 4.8** Dependence of temperature in the furnace on the duration of fire exposure: 1 – curve of standard temperature regime; 2 – real curve of temperature change in the furnace

The following technical equipment were used for testing:

- test furnace;
- measuring equipment;
- support structure for samples.

The test furnace and measuring equipment complied with [215].

Support structure – a reinforced concrete slab with one or more square holes  $450 \pm 10$  mm in size for the samples to be tested. The thickness of the supporting structure at the place of installation of the samples was 60 mm.

The temperature from the unheated surface in 17 minutes of testing reached the critical temperature for the steel plate (550 °C) (**Fig. 4.9**).

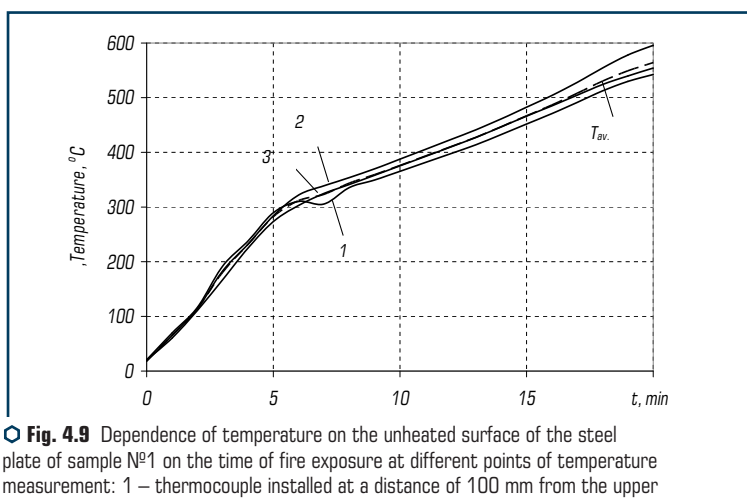

**Fig. 4.9** Dependence of temperature on the unheated surface of the steel plate of sample №1 on the time of fire exposure at different points of temperature measurement: 1 – thermocouple installed at a distance of 100 mm from the upper edge of the plate; 2 – thermocouple mounted in the center of the plate; 3 – thermocouple installed at a distance of 100 mm from the lower edge of the plate;  $T_{av}$  – the average value of the three thermocouples

Achieving a critical temperature (550 °C) from the unheated surface of the control plates and plates with aged flame retardant coating occurred almost simultaneously. These results coincide with the manufacturer's data on the durability of the coating and indicate the adequacy of the proposed method for determining the durability of fire-retardant coatings of steel structures.

The appearance of the samples after the fire tests is shown in **Fig. 4.10**.

Subsequently, when determining the thermophysical characteristics of the coating used the average value of the three thermocouples (**Fig. 4.10**).

The following are the results of the study on the example of sample № 1.

After tests on visual inspection of the samples found:

- fire-retardant substance applied to a steel plate, dimensions 500×500×5 mm with soil GF-021 (thickness 0.065 mm), has satisfactory adhesive strength;
- exfoliation of the formed coating from the steel plate by area was not observed;
- the average thickness of the swollen layer after the tests was 12 mm (8–16 mm).



○ Fig. 4.10 Characteristic appearance of a swollen fire-retardant coating after fire exposure

To determine the characteristics of the fire-retardant ability of coatings of steel structures using the calculation-experimental method used developed physical (Fig. 4.2) and mathematical (4.1)–(4.6) models of thermal processes occurring in such a system in tests.

Since the coating under study is reactive, i.e., swellable (with the possibility of increasing the initial thickness of the coating up to 100 times), so the law of increasing the initial thickness of the coating during heating is not known.

The question arises as to the thickness to which the obtained coefficients of effective thermal conductivity and specific volumetric heat capacity of the coating.

It is accepted that the obtained coefficients of effective thermal conductivity and specific volumetric heat capacity of the coating refer to the initial thickness of the coating. Therefore, the calculated models of the thermal conductivity process with coatings were also taken with the thicknesses of coatings that do not change over time.

The obtained data (temperatures from the unheated surface of the steel plate) were used in solving the inverse problems of thermal conductivity.

As a result of calculations, the thermophysical characteristics of the fire-retardant coating are determined: the dependence of the thermal conductivity coefficient on temperature (Fig. 4.11) and the constant value of the specific volumetric heat capacity  $1\cdot105 \text{ J/m}^3\cdot^\circ\text{C}$ . The inverse problem of thermal conductivity was solved by an extreme method based on the use of

the iterative Newton-Gauss method of finding the minimum of the function  $F$  and the A. Tikhonov regularization method [205].

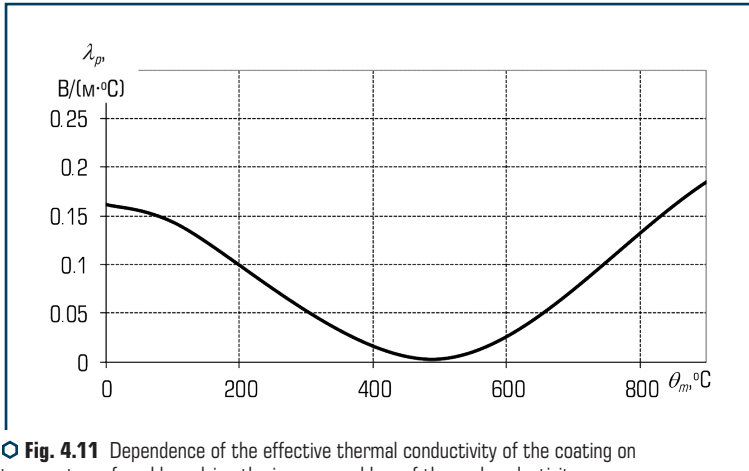

Fig. 4.11 Dependence of the effective thermal conductivity of the coating on temperature, found by solving the inverse problem of thermal conductivity

The curve of the obtained dependence of the thermal conductivity of the fire-retardant coating on temperature can be explained as follows (Fig. 4.11). The value of the thermal conductivity from the initial temperature to 500 °C decreases linearly, due to swelling of the coating and an increase in thickness tenfold relative to the initial thickness. Linear growth after 500 °C is caused by an increase in the radial component of the thermal conductivity and its conductive component (due to shrinkage (sintering) of the coke layer of the coating and partial destruction).

Using the found thermophysical characteristics of the coating by solving a series of direct problems of thermal conductivity, the dependence of the minimum thickness of the studied coating on the thickness of the steel plate, the normalized duration of fire and the critical temperature of steel.

As a result of the conducted research it is established that the influence, which corresponds to 3 years of operation, does not affect the thermophysical characteristics of the studied coating, and hence the fire-retardant ability [216–229].

The advantage of the proposed technique is the ability to determine the parameters of fire-retardant coatings in much less time than full-time climatic tests in real time. These results will allow to approach the assessment of fire resistance of steel structures with fire protection with prolonged use with increased accuracy. The research will be useful for designers, manufacturers of fire-retardant substances, because it will allow to calculate such thicknesses of coatings that would provide a normalized limit of fire resistance of the structure, taking into account the time of use.



#### 4.3.2 DETERMINATION OF THE INFLUENCE OF TEMPERATURE REGIMES OF FIRE (ON THE EXAMPLE OF THE TEMPERATURE REGIME OF HYDROCARBON FIRE)

Steel structures are widely used in the construction of various buildings and structures. Due to the high strength and density of the metal, the efficiency of joining elements, a high degree of industrial manufacturing and installation, relatively low weight, gas and water resistance, such structures provide rapid installation of buildings and structures and accelerate their commissioning. However, in the event of a fire, the steel quickly loses its strength, which ultimately leads to a loss of load-bearing capacity until the destruction of the building.

This occurs at a temperature of 350–750 °C, depending on the grade of steel, the reduced thickness of the metal and the load on the structure. In Ukraine at the moment the temperature of 500 °C is defined as the main critical (design) temperature of steel structures with fire-retardant coatings and facings according to [233]. Requirements for the limits of fire resistance of building structures are given in [see Table 1, 234], which indicates that in buildings and structures of I–III degree of fire-resistance, the use of unprotected steel structures is not possible. Fire resistance of fire-retardant steel structures and their elements is normalized and determined by fire resistance tests at standard fire temperature, which does not always meet modern fire safety requirements for buildings and structures.

Thus, the analysis of resonant fires that occurred at facilities using metal structures, conducted in recent years, showed that one of the reasons for the mismatch of the limit of fire resistance of metal structures and, as a consequence, the collapse of buildings, there is an incorrect determination of the dependence of the coating thickness on the thickness of the metal structure for the normalized values of the limit of fire resistance [235]. It is possible to assume that determining the characteristics of the fire-retardant ability of coatings in those fire modes that correspond to their real working conditions, would avoid such cases.

To confirm the fire resistance in conditions of more intense exposure than at standard temperatures, a hydrocarbon curve is used, which is determined by the dependence:

$$T = 1080(1 - 0.325 \cdot e^{-0.167t} - 0.675 \cdot e^{-2.5t}) + 20, \quad (4.13)$$

where  $T$  – the temperature of the gaseous medium near the structure, °C;  $t$  – time, min.

Hydrocarbon fire is characterized by a rapid rise in temperature to above the temperature of a standard (cellulose) fire and is accompanied by the impact of a wave of flame on fire-retardant coatings on the surface of a metal structure. In such conditions, traditional fire-retardant materials do not provide the required level of fire-retardant efficiency.

The hydrocarbon fire mode reaches a value of 1100 °C for 5 minutes, which is almost twice the temperature of a standard fire in the same period of time. It is possible to assume that the physico-chemical processes occurring in the fire-retardant coating will be different, and the thermophysical characteristics of this coating under different modes will be different.

Especially interesting are the tests of fire-retardant compositions according to UL 1709 (Underwriters Laboratory, USA). This standard is the first of the standards in which the hydrocarbon combustion regime was presented. UL 1709 determines the stability of fire-retardant coatings in the temperature regime at which the temperature of 1100 °C is reached in the first 5 minutes of combustion. This temperature is maintained throughout the test period.

In addition, tests are carried out according to the standard of “direct impact” of the jet flame (Jet Fire) (Lloyd’s Register), which is also not reflected in domestic regulations.

International Standards ISO 22899-1:2007 and ISO/TR 22899-2 describe a method (similar to the method described in UL 1709) that gives an idea of the behaviour of fire-retardant materials and steel structures under the influence of reactive flames. Reactive flame is modelled by the emission of high pressure combustible gases, liquefied gas and combustible liquid fuel, which increases the thermal and mechanical loads on fire-retardant materials, increases convective and radiative heat flux, leading to intense erosion. To create such conditions, this method involves placing the sample in a hollow chamber with a pipe (**Fig. 4.12**), through which the gas is released, resulting in the formation of a fireball. Propane is used as fuel. High erosion rates are formed due to the high-velocity gas jet passing over the surface of the sample. The jet velocity is about 60–100 m/s. The average heat flux is about 240 kW/m<sup>2</sup> [102, 236].



The main disadvantage of such test methods is the use of rather cumbersome and expensive equipment, which makes it appropriate to develop more economical and simple test methods. In

addition, the presented techniques do not guarantee the repeatability of the conditions of the experiment, as the parameters of high-speed gas flow (speed, temperature) in interaction with the fire-retardant coating can change significantly and are difficult to control.

According to the above data, testing of fire-retardant coating in the conditions of standard temperature regime is not a sufficient basis for its use as fire-retardant steel structures of oil and gas industry facilities. When providing fire protection for such facilities, you should focus on the real and the most severe situations that may arise during a fire. The development of fire protection measures should be carried out taking into account the specific fire effects and testing the effectiveness of fire protection – at different temperatures, depending on the operating conditions of such coatings.

Therefore, in order to correctly determine the characteristics of the fire-retardant ability of coatings of steel structures for the temperature curve of hydrocarbon fire, it is necessary to conduct fire tests of this structure with a certain fire-retardant coating in this fire mode. In this case, the data obtained during such fire tests (temperature), use to find the thermophysical characteristics of the coating [237, 238].

To do this, the paper proposes to apply the developed calculation and experimental method for estimating the fire resistance of fire-retardant steel structures [239–241].

The main difficulties in determining the fire-retardant ability of coatings of fire-retardant steel structures at different fire temperatures include:

- the dependence of the coefficient of swelling of the fire-retardant coating of steel structures on the rate of heating of the coating, which in turn depends on the mode of fire (level and rate of temperature change) and the thickness of the structure;
- dependence of thermophysical characteristics of fire-retardant coatings of steel structures on the rate of heating of the coating for the same reasons;
- conducting tests for fire resistance of steel structures in fire conditions other than standard (the norms do not provide for such tests, so the manufacturers of coatings do not conduct such tests);
- in the case of application of calculation methods for determining the fire-retardant ability of coatings of steel structures, the question arises about the use of thermophysical characteristics of fire-retardant coatings, which were determined at the standard temperature of the fire.

Fire-retardant treatment of the structure consisted in the application of anti-corrosion primer GF-021 and fire-retardant on the prepared surface of the steel plate.

To prepare the surface for anti-corrosion coating used methods of abrasive cleaning, washing with a jet of water under pressure, cleaning from dust with compressed air. The recommended level of cleaning of the surface of the steel structure is characterized by the fact that when visually inspected with the naked eye, the prepared surface should be free of oils, grease, dirt, rolled scale, rust, paint and foreign particles.

The time interval between surface preparation and anti-corrosion coating application did not exceed 24 hours indoors and 6 hours outdoors.

All operations on the application of flame retardants were performed in accordance with the manufacturer's instructions and in accordance with the instructions given in the Technical Specifications and in the Safety Data Sheet for the application of swellable systems. No product, with the exception of inorganic substances, was applied at temperatures below the dew point.

On the surface of the steel plate, before applying the flame retardant was applied a layer of soil GF-021, 0.065 mm thick. The substance was applied in a mechanized way by an airless spraying unit (**Fig. 4.13**) in accordance with the regulations of fire protection works.



**Fig. 4.13** General view of the airless spraying unit

This method is the most used and economical for the application of large thicknesses of high-viscosity paints, which include reactive coatings.

The equipment consists of a pump, the main parts of which are a tank, electric or pneumatic motor and a gun equipped with special spray nozzles and an automatic nozzle cleaning system.

The effectiveness of a reactive flame retardant system depends on the characteristics of the substances used, methods and conditions of their application, as well as on the characteristics of the system, i.e. the physical parameters characterizing the layer of the system (thickness and adhesion) for the required fire resistance.

To ensure the performance of the fire-retardant ability of the formed fire-retardant coating, it is necessary to scrupulously follow several rules of "correct application", paying special attention to the condition of applied paints and varnishes, methods of application, environmental conditions (at the time of application). the thickness of the different layers of the coating, the drying time of each layer and the characteristics of the upper protective (decorative) layer (if necessary).

Before applying the paint, the entrance control was carried out, which consisted of checking the integrity of the packaging, the presence of markings and compliance with the expiration date. Before use, the paint was thoroughly mixed in the factory container using an electric mixer.

Among the variety of fire-retardant substances, a special place is occupied by those that swell under the action of high temperature, forming a layer of porous coating, which has good thermal

insulation properties. One such substance is “Amotherm Steel Wb”, manufactured by the Italian company Amonn Fire S.r.l.

To determine the fire-retardant ability of this coating, fire tests of two steel plates St3 were planned and carried out, dimensions of which 500×500×5 mm with inflated flame retardant composition “Amotherm Steel Wb”, which is water-based.

To measure the thickness of the formed fire-retardant coating, a thickness gauge was used, which was measured at 9 points (**Fig. 4.14**), the average thickness was 0.42 mm.

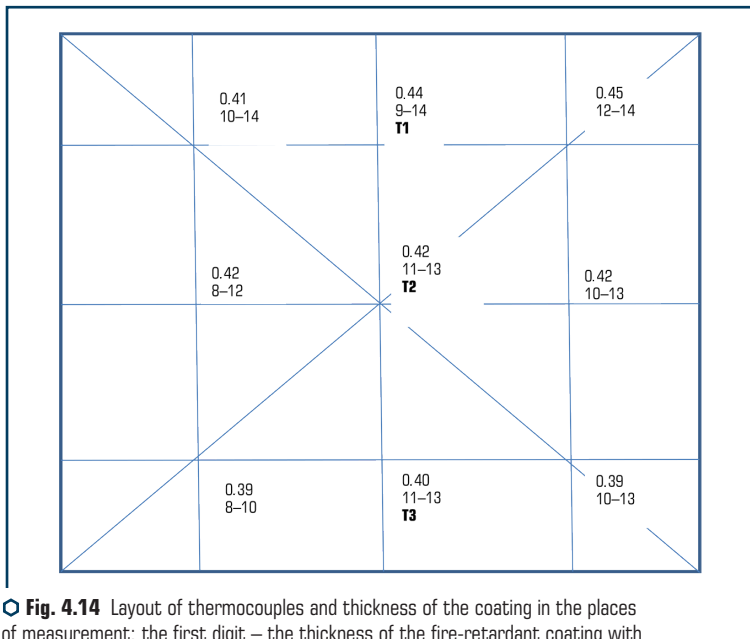

**Fig. 4.14** Layout of thermocouples and thickness of the coating in the places of measurement: the first digit – the thickness of the fire-retardant coating with soil, mm; the second digit – the thickness of the swelling, mm; the third digit – the location of the thermocouple

To measure the temperature from the unheated surface of the steel plate, 3 thermocouples of the THA type (**Fig. 4.15**) with a wire diameter of 0.5 mm (T1–T3), one thermocouple (T2) in the center of the sample and two (T1, T3) at a distance of 100 mm from the edges of the plate. Thermocouple joints are hammered into the metal to a depth of 2 mm and attached with heat-insulating material.

From the unheated surface the plate was protected by two layers of mulico-silica felt, 20 mm thick, and a plate of mineral wool, density 75 kg/m<sup>3</sup> and thickness 50 mm.

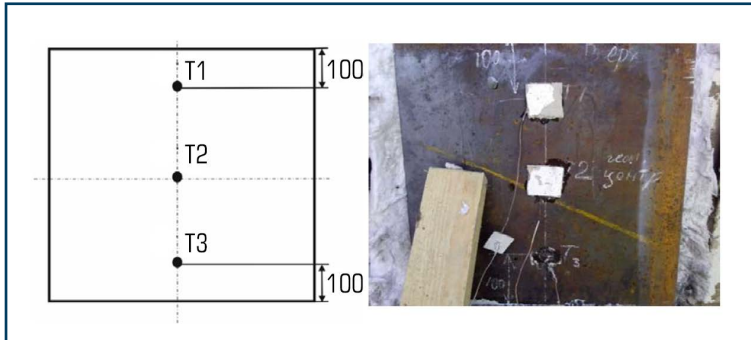

○ Fig. 4.15 Layout of thermocouples from the unheated surface of the steel plate

The essence of the test was to create a temperature regime in the furnace, close to the regime of hydrocarbon fire, during the thermal action on the test sample and determine the time from the beginning of thermal action to a temperature of 500 °C from the unheated surface of the steel plate.

The tests were performed at an air temperature of 20.8 °C, relative humidity of 48 % and pressure of 743 mm Hg.

Tests of samples were carried out in conditions close to the temperature of the hydrocarbon fire for 15 minutes (Fig. 4.16).

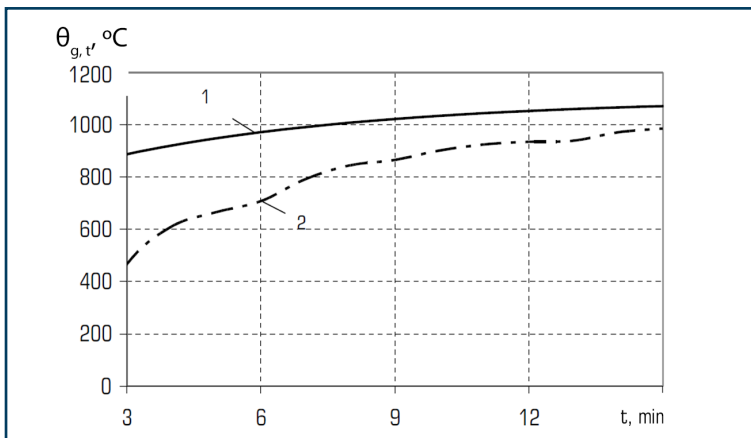

○ Fig. 4.16 Dependence of temperature in the furnace on duration of fire influence: 1 – curve of a temperature mode of a hydrocarbon fire; 2 – temperature curve during the experiment in the furnace

As can be seen from **Fig. 4.16**, the temperature in the furnace at the initial time up to 3 min differs from the hydrocarbon fire curve, as it is very difficult to ensure a rapid rise in temperature in the first minutes of the test. After 3 minutes of testing, the actual temperature in the furnace begins to approach the temperature of the hydrocarbon fire and up to 15 minutes reaches 985.9 °C. The temperature from the unheated surface in this 15-minute test reached a critical temperature for a steel plate of 500 °C (**Fig. 4.17**).

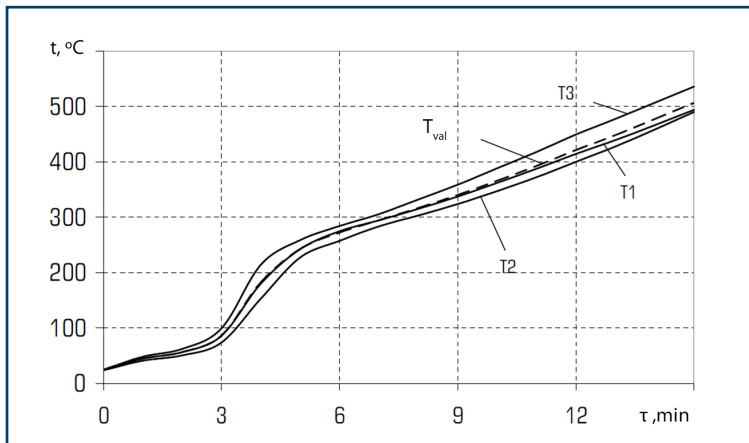

**Fig. 4.17** Dependence of temperature from the unheated surface of the steel plate on the time of fire exposure at different points of temperature measurement: T1 – thermocouple installed at a distance of 100 mm from the upper edge of the plate; T2 – thermocouple installed in the center of the plate; T3 – thermocouple installed at a distance of 100 mm from the lower edge of the plate;  $T_{av}$  – the average value of the three thermocouples

As can be seen from **Fig. 4.17**, the nature of the curves of the temperature dependence of the unheated surface of the steel plate on the time of fire coincides. It is established that the plate is evenly heated in different parts of the temperature measurement, and the differences in the observed heating rate are explained by the heterogeneity of the thickness of the fire-retardant coating (**Fig. 4.15**).

For thermal calculations took the average value of the three thermocouples installed from the unheated surface of the steel plate (**Fig. 4.17**).

After tests at visual inspection of samples it is established (**Fig. 4.18**):

- investigated fire-retardant substance applied to a steel plate, dimensions 500×500×5 mm with soil GF-021 (thickness 0.065 mm), has satisfactory adhesive strength;
- exfoliation of the formed coating from the steel plate by area was not observed;
- the average thickness of the expanded layer after the tests was 10 mm (8–14 mm).



○ **Fig. 4.18** General view of "Amotherm Steel Wb" coated steel plate after testing

Comparing the heating time of the steel plate with the studied fire-retardant coating under the fire of hydrocarbon and standard fire, it follows that at a coating thickness of 0.42 mm, the time during which a 5 mm thick steel plate is heated to a critical temperature of 500 °C at standard temperature 1.9 times higher than the temperature of the hydrocarbon fire (**Fig. 4.19**) [240].

From **Fig. 4.19** it follows that the steel plate, and therefore the steel structure, in harsher fire conditions will heat up faster, and therefore the thickness of the fire-retardant coating to ensure the normalized limit of fire resistance should be greater. This indicates differences in the values of the limit of fire resistance of steel structures when used on objects of different functional purpose [241–244].

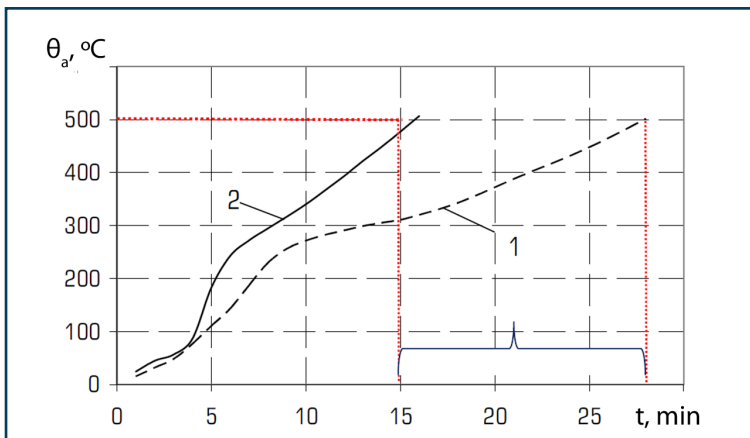

○ **Fig. 4.19** Dependence of temperature on an unheated surface of a steel plate on time of fire influence at various temperature modes of fire: 1 – standard fire; 2 – hydrocarbon fire



Based on the obtained data (temperature of the unheated surface of the steel plate), solving the inverse thermal conductivity problem, calculated the thermophysical characteristics of the fire-retardant coating: the dependence of the thermal conductivity on temperature (**Fig. 4.20**) and the constant value of specific heat. The inverse problem of thermal conductivity is solved by the extreme method based on the use of the iterative Newton-Gauss method of finding the minimum of the function  $F$  and the A. Tikhonov regularization method [205].

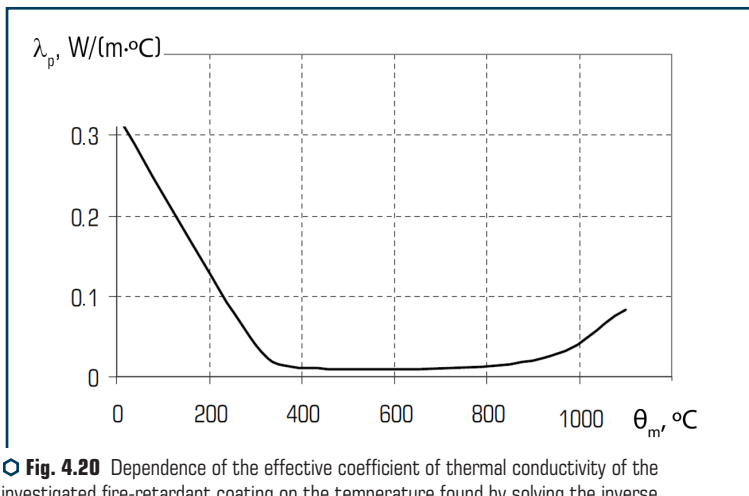

**Fig. 4.20** Dependence of the effective coefficient of thermal conductivity of the investigated fire-retardant coating on the temperature found by solving the inverse problems of thermal conductivity

As can be seen from **Fig. 4.20**, in the temperature range from the initial temperature to 400 °C the value of the thermal conductivity of the studied coating decreases, which can be explained by swelling of the coating and increasing its porosity and passes through a minimum value of approximately 0.01 W/m·°C (at 400 °C to 1000 °C). The increase in the coefficient of thermal conductivity in the temperature range after 1000 °C is due to the appearance of the radiation component in the pores of the coating in combination with its high-temperature shrinkage and charring.

The constant value of the specific volumetric heat capacity was  $C_v = 6 \cdot 10^4 \text{ J/m}^3 \cdot \text{°C}$ . The greatest convergence of experimental and calculated temperatures was observed, and the criterion of standard deviation was 12.5 °C.

It is assumed that the obtained effective coefficient of thermal conductivity (**Fig. 4.20**) and the specific volumetric heat capacity of the coating refers to the initial thickness of the coating, so the calculated models of the thermal conductivity process were also taken with the coating thickness constant over time. Based on the obtained thermophysical characteristics of the coating, using previously developed models [240] determined the dependence of the thickness of the investigated

fire-retardant coating on the thickness of the steel plate when tested in temperatures close to hydrocarbon fire.

Using the developed mathematical model of thermal state in the system “fire-retardant coating – steel plate” and data on thermophysical characteristics of fire-retardant coating [233], by solving a series of direct problems of thermal conductivity determined the dependence of minimum coating thickness on steel plate thickness  $C$  and the normalized duration of fire 30 minutes (**Fig. 4.21**). Direct problems of thermal conductivity were solved by the numerical method of finite differences. The number of nodes was 25 in spatial coordinates, a time step of 30 s.

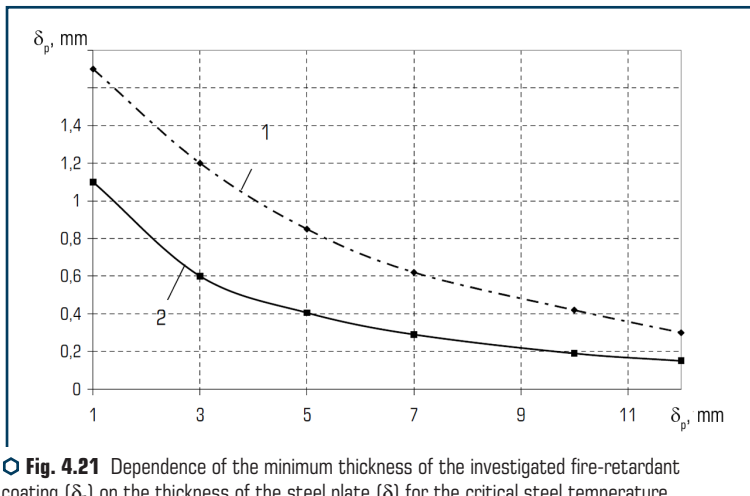

**Fig. 4.21** Dependence of the minimum thickness of the investigated fire-retardant coating ( $\delta_p$ ) on the thickness of the steel plate ( $\delta$ ) for the critical steel temperature of 500 °C and the normalized duration of fire exposure of 30 minutes: 1 – at the temperature of hydrocarbon fire; 2 – at standard fire temperature

Comparing the dependences shown in **Fig. 4.21**, it can be concluded that the values of the minimum thickness of the flame retardant coating for fire exposure in the temperature regime of the hydrocarbon fire is 2 times greater than for the standard temperature regime. This indicates the need to assess the fire-retardant effectiveness of coatings of steel structures, taking into account the specific fire regimes that meet the operating conditions of the buildings and structures.

## CONCLUSIONS ON SECTION 4

1. Physical and mathematical models for assessing the fire resistance of fire-retardant steel structures have been developed. An algorithm is used, which includes experimental and computational procedures in determining the fire resistance of fire-resistant steel structures. The initial and

boundary conditions for the construction of these models are formulated, which allow to predict the fire resistance of the fire-retardant steel structure with sufficient accuracy for engineering calculations. The peculiarity of the developed models is taking into account the thermophysical characteristics of steel structures and fire-retardant coatings, as well as taking into account the peculiarities of the formation of fire regimes.

2. Based on the offered physical and mathematical models the calculation-experimental method of estimation of fire resistance of fire-protected steel designs is developed. The method is based on the use of samples of reduced size, which facilitates the procedure of determining the normalized values of the limit of fire resistance. The structural-logical scheme of realization of the developed method provides 9 blocks located in 5 levels connected by logical connections and includes experimental and computational parts. The experimental part of the method involves the study of the temperature of fire-retardant steel plates under fire conditions for specified fire conditions (standard, external, hydrocarbon, tunnel, real fire) and taking into account climatic factors on the coating. Calculation part – construction of mathematical, physical, geometric, computer models of processes occurring in the studied fire-retardant steel structure, identification of thermophysical characteristics of fire-retardant coating (coefficient of thermal conductivity, specific volumetric heat capacity) by solving inverse problems of thermal conductivity the ability of fire-retardant coating by solving direct problems of thermal conductivity.

3. The efficiency of the developed computational-experimental method for assessing the fire resistance of fire-resistant steel structures by using samples of reduced size 500×500×5 mm, covered on one side with reactive flame retardant “Phoenix STS” with an average thickness of 0.31 mm in standard temperature conditions fires after the impact on the formed coating of climatic factors corresponding to the service life of the coating 3 years. It is established that the values of the coefficient of thermal conductivity of the reactive flame retardant coating “Phoenix STS”, identified after the influence of these climatic factors, are like the values of this coefficient without influence. In general, the efficiency of the proposed calculation and experimental method for assessing the fire resistance of fire-resistant steel structures is confirmed.

4. Approbation of the developed calculation-experimental method at estimation of fire resistance of fire-resistant similar steel plates covered on the one hand with reactive fire-retardant coating on water basis “Amotherm Steel Wb” in the conditions of heating in the fire furnace at a hydrocarbon fire temperature is carried out. The effective coefficient of thermal conductivity and the specific volumetric heat capacity ( $6 \cdot 10^4 \text{ J/m}^3 \cdot ^\circ\text{C}$ ) of the investigated fire-retardant coating at the temperature regime of hydrocarbon fire were found. It is established that in the temperature range from the initial temperature to 400 °C the value of the thermal conductivity coefficient of the fire-retardant coating decreases, which is explained by the swelling of the coating and the increase in its porosity. In the future, the value of the thermal conductivity acquires a minimum value of about 0.01 W/m·°C (at a temperature of 400 °C to 1000 °C). The increase in the coefficient of thermal conductivity in the temperature range after 1000 °C is due to the appearance of the radiation component in the pores of the coating in combination with its high-temperature shrinkage

and charring. The relationship between the thickness of the investigated reactive flame retardant coating and the thickness of the steel structure is revealed, as well as the necessary calculated minimum thicknesses of such coating to ensure fire resistance at 30 minutes for hydrocarbon fire temperature conditions. It is established that in order to achieve such a limit of fire resistance, the value of the minimum thickness of the investigated fire-retardant coating requires a 2-fold increase for the fire effect of a hydrocarbon fire in comparison with the conditions of the standard temperature regime.

**ABSTRACT**

---

The reliability of the developed mathematical model and calculation-experimental method for estimating the fire resistance of fire-resistant reinforced concrete structures using the method of computational experiment is verified. It is established that random errors of 10 % when measuring temperatures from the unheated surface of the fire-retardant floor significantly affect the accuracy of determining the thermophysical characteristics of the coating (maximum error up to 30 %). The calculated finite-element model of the system “steel plate – fire-retardant coating” for modelling non-stationary heating of such a system in the ANSYS software package has been developed. Using this model, calculations of the thermal state of the steel plate with a minimum thickness of the fire-retardant coating of 0.248 mm were performed. An installation for determining the adhesive strength of fire-retardant coatings for the protection of steel structures has been developed. The reliability and operability of the proposed installation were tested on the example of the study of the adhesive strength of three fire-retardant coatings. It was found that all coatings have high adhesion to the steel surface (more than 3 MPa/cm<sup>2</sup>).

**KEYWORDS**

---

Reliability, mathematical model, sensitivity analysis, perturbation, finite element model, ANSYS software package, error, adhesive strengths.

**5.1 VERIFICATION OF THE RELIABILITY OF THE DEVELOPED MATHEMATICAL MODEL AND  
METHOD FOR ASSESSING THE FIRE RESISTANCE OF FIRE-RETARDANT REINFORCED  
CONCRETE STRUCTURES**

The reliability of the calculation of the thermal regime of reinforced concrete structures, both with fire-retardant coatings and without them, is largely determined by the accuracy of parameters of the mathematical model, which ensures its adequacy to real heat transfer processes in fire resistance tests.

Among the parameters of the model, it is necessary to identify those that are unknown or insufficiently known and most affect the calculated values of temperatures of the selected mathematical model.

The process of determining the degree of influence of the model parameters on the initial result (in our case the temperature) is called sensitivity analysis.

The ratio of the standard deviation of temperatures to the relative value of the change in the analyzed parameter of the model  $P_i$  is chosen as the sensitivity coefficient (5.1).

$$F_i = \frac{F}{\Delta P_i / P_i}, \quad (5.1)$$

where  $F$  – root mean square deviation of temperature over time;  $\Delta P_i$  – the magnitude of the deviation of the  $i$ -th parameter relative to its value  $P_i$ .

The method of sensitivity analysis consists in sequential perturbation of model parameters, identification of thermophysical characteristics and solution of a series of direct problems of thermal conductivity to obtain values of standard deviation of temperature in time and direct calculation of sensitivity coefficients  $F$  (Table 5.1).

● **Table 5.1.** Sensitivity of temperatures at the measuring points to the parameters of the model of thermal conductivity of fire-retardant plaster-coated reinforced concrete structure (on the example of multi-hollow reinforced concrete floor)

Nº	Parameter name	$F_i$ value
1	Thermal conductivity coefficient $\lambda$ of plaster coating	4.72
2	Specific volumetric heat capacity of concrete $C_v$ of layers 1, 3, 5 of overlapping	2.7
3	Specific volumetric heat capacity of concrete $C_v$ of layer 2	1.94
4	Coefficient of thermal conductivity of concrete $\lambda$ of layers 1, 3, 5 of overlapping	0.26
5	Heat transfer coefficient $\alpha_{e2}$ from the concrete non-heated surface of the reinforced concrete structure	0.22
6	Coefficient of thermal conductivity $\lambda$ of layer 2	0.2
7	Specific volumetric heat capacity of plaster coating $C_v$	0
8	Degree of blackness of concrete	0
9	Heat transfer coefficient $\alpha_{e1}$ from hot gases to the heating surface	0

**Table 5.1** presents, in descending order, the quantitative effect of different parameters of the mathematical model on the temperature in the fire-retardant reinforced concrete structure at the measurement points. It is established that the following parameters of the model have the greatest influence: the coefficient of thermal conductivity  $\lambda$  of plaster coating and the specific volume heat capacity of concrete  $C_v$  layers 1, 3, 5. These results allowed us to determine the list of parameters of the mathematical model that must be calculated using inverse thermal conductivity problems according to fire resistance tests with sufficient accuracy [198, 213].

An important aspect in the study of fire resistance of fire-retardant reinforced concrete building structures is to determine the thermophysical characteristics of fire-retardant coatings, as

well as the correctness and accuracy of these characteristics, taking into account possible errors in measuring temperatures from unheated surface of fire-retardant reinforced concrete structures. Failure to take into account or neglect possible errors in temperature measurement can lead to inaccurate determination of thermophysical characteristics of coatings, and subsequently – to incorrect determination of fire resistance of fire-retardant reinforced concrete structures, which will negatively affect the main indicators of fire statistics [245].

When testing the fire resistance, there are measurement errors, which are taken into account in the computational experiment by introducing into the values of temperatures obtained by 5 thermocouples (**Fig. 5.1, b**), random errors corresponding to the level of real measurement errors.

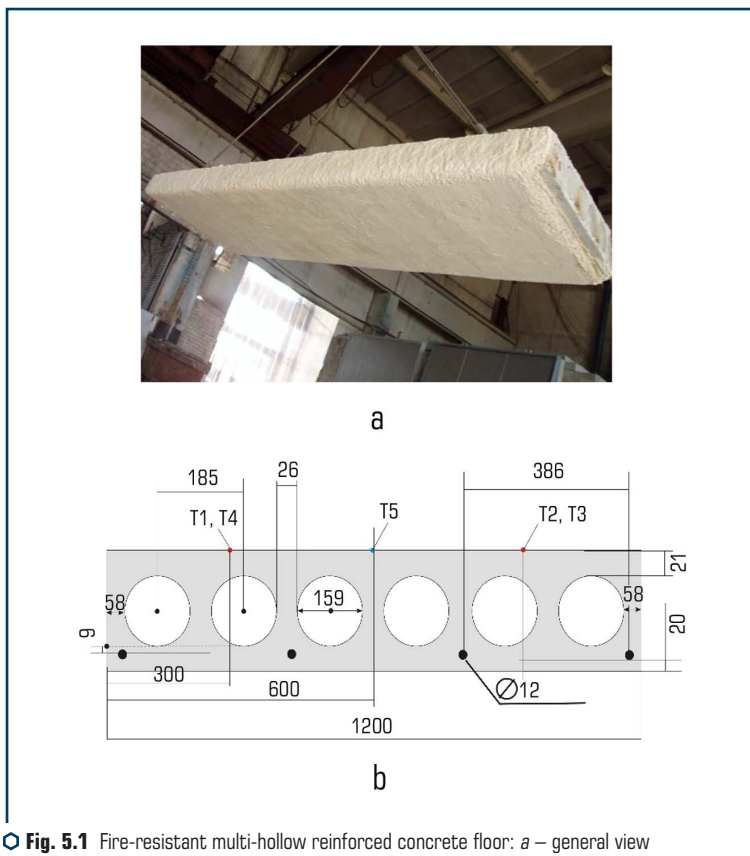

A computational experiment simulating a fire resistance test was performed, as a result of which the calculated values of temperatures from the unheated surface of the fire-resistant multi-hollow reinforced concrete floor were obtained (**Fig. 5.2**). A study of the influence of errors in measuring the temperature of the unheated surface of reinforced concrete multi-hollow floor on the accuracy of determining the thermophysical characteristics of the plaster coating [245]. Random errors of 10 % in the measurement of temperatures from the unheated floor surface using a random number generator were introduced.

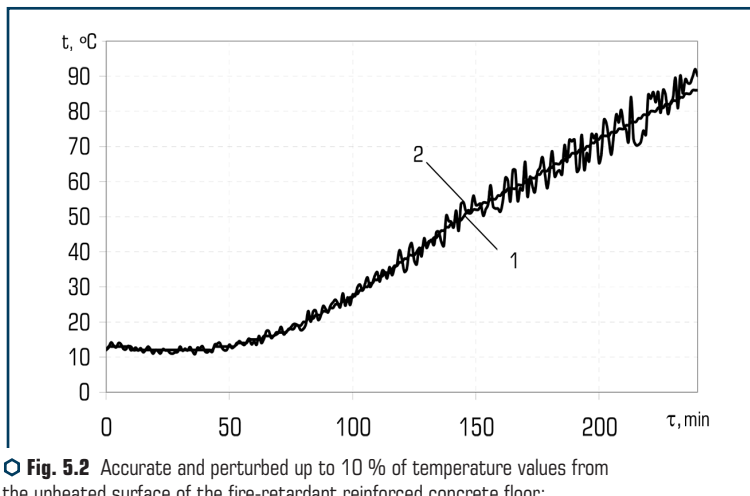

**Fig. 5.2** Accurate and perturbed up to 10 % of temperature values from the unheated surface of the fire-retardant reinforced concrete floor:  
1 – exact curve; 2 – curve perturbed by 10 %

Next, the thermophysical characteristics of the studied plaster coating were found on the temperatures perturbed by 10 % from the unheated surface of the fire-retardant floor, by solving the inverse problems of thermal conductivity (**Fig. 5.3**).

As can be seen from **Fig. 5.3**, random errors in measuring temperatures from the unheated surface of fire-retardant reinforced concrete floors, affect the accuracy of determining the thermophysical characteristics of the coating under study (maximum error up to 30 %) [220].

It can be assumed that such deviations are due to the design of multi-hollow slabs in combination with the peculiarities of mass transfer of moisture (natural and chemically bound) at high temperatures.

Along with the main parameters (coefficient of thermal conductivity  $\lambda$  of plaster coating and specific volumetric heat capacity of concrete  $C_V$ , layers 1, 3, 5), which affect the accuracy of determining the thermophysical characteristics and fire-retardant capacity of the coating (**Table 5.1**), is the heat transfer coefficient  $\alpha_{e2}$  from concrete unheated surface of the floor slab.



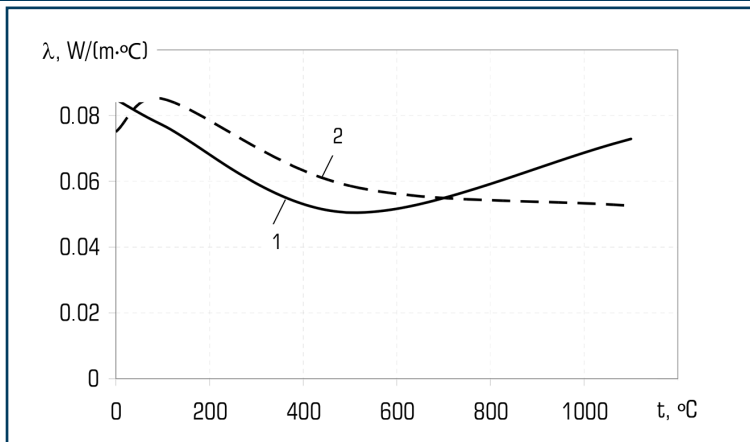

○ **Fig. 5.3** Dependence of the effective coefficient of thermal conductivity of the investigated plaster coating on temperature: 1 – exact coefficients; 2 – coefficients obtained by solving the inverse problems of thermal conductivity at perturbed temperatures by 10 %

The developed one-dimensional physical model of the thermal state of the reinforced concrete floor with a breakdown of the slab into 6 layers was applied (**Fig. 5.4**).

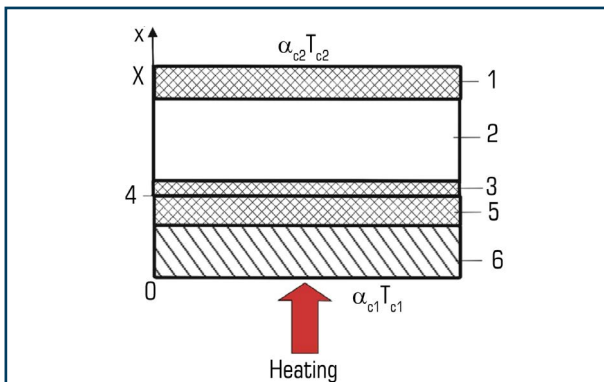

○ **Fig. 5.4** Scheme of multi-hollow reinforced concrete floor in one-dimensional formulation: 1 – a layer of solid concrete between the unheated surface and the layer with floor cavities; 2 – layer with voids; 3 – a layer of solid concrete between the cavities and reinforcement; 4 – armature layer; 5 – a layer of solid concrete from the reinforcement to the heated surface; 6 – plaster coating

The mathematical model of the thermal conductivity process in such a six-layer system in the Cartesian coordinate system, which describes the physical model discussed above (**Fig. 5.4**), is a one-dimensional equation of thermal conductivity with a combination of radiant heat transfer and boundary conditions of the third kind on the heated surface, and boundary conditions of the third kind from the unheated surface, taking into account the ambient temperature [221].

The system of equations of the mathematical model was solved numerically by the method of finite differences by solving the inverse problems of thermal conductivity according to fire resistance tests, with heat transfer coefficient  $\alpha_{c2}$ , which was set within 3–7 W/(m<sup>2</sup>·°C), and depending on from the temperature. As a result of the study, the dependences of the effective thermal conductivity of the plaster coating on the temperature found by solving the inverse problems of thermal conductivity according to fire resistance tests (**Fig. 5.5**).

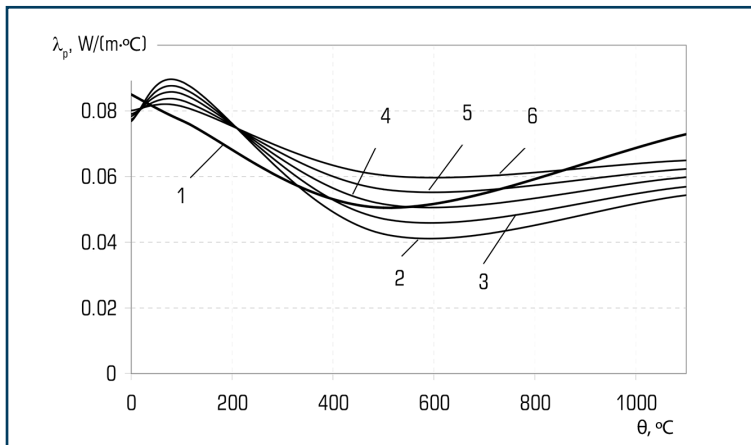

**Fig. 5.5** Dependence of the effective coefficient of thermal conductivity of the plaster coating on the temperature found by solving the inverse problems of thermal conductivity according to the data on fire resistance tests: 1 – at  $\alpha_{c2}$ , which depends on the temperature; 2 –  $\alpha_{c2}=3$  W/(m<sup>2</sup>·°C); 3 –  $\alpha_{c2}=4$  W/(m<sup>2</sup>·°C); 4 –  $\alpha_{c2}=5$  W/(m<sup>2</sup>·°C); 5 –  $\alpha_{c2}=6$  W/(m<sup>2</sup>·°C); 6 –  $\alpha_{c2}=7$  W/(m<sup>2</sup>·°C)

As can be seen from **Fig. 5.5**, with increasing heat transfer coefficient from the unheated surface of the coated reinforced concrete floor, the error in determining the thermal conductivity increases and is 25 % (for  $\alpha_{c2}=7$  W/(m<sup>2</sup>·°C)). It is established that this coefficient needs special attention, and the most correct way is to set it as a function of temperature (**Fig. 5.5**, curve 1). The values of this parameter are decisive in influencing the fire resistance of the studied fire-retardant multi-hollow reinforced concrete floors, and hence the recommendations for the accuracy of determining both thermophysical characteristics and subsequent characteristics of fire-retardant capacity of fire-retardant coatings, fire-retardant reinforced concrete structures [220].

Thus, this section investigates the effect of errors in measuring temperatures from the unheated surface of fire-retardant reinforced concrete structure (for example, multi-hollow reinforced concrete floor) on the error of determining the thermophysical characteristics of the studied plaster coating and found that random errors of 10 % when measuring temperatures from the unheated surface of the fire-retardant floor, significantly affect the accuracy of determining the thermophysical characteristics of the coating (maximum error up to 30 %).

It is established that when assessing the fire resistance of fire-retardant multi-hollow reinforced concrete floors, the heat transfer coefficient between the unheated floor surface and the environment affects the accuracy of determining the thermophysical characteristics of fire-retardant coating, so it must be set depending on temperature.

The peculiarities of the influence of fire temperature regimes on the characteristics of fire-retardant ability of coatings of fire-retardant reinforced concrete structures are also revealed.

Attention is paid to the study of the efficiency of the proposed calculation and experimental method in conditions of fire temperatures other than standard and arbitrary values of the thickness of the fire-retardant coating at a given thickness of the protective layer of concrete floor. For this purpose, several thermal conductivity test problems were solved according to the data of a computational experiment, i.e. solving a number of direct thermal conductivity problems with given thermophysical characteristics of concrete and fire-retardant coating on the example of multi-hollow reinforced concrete floor – structure, which has the most complex structure (the presence of voids) and, accordingly, the most complex procedure for calculating non-stationary heating of the fire-retardant structure.

The solution scheme was chosen as close as possible to the tests for fire resistance of multi-hollow reinforced concrete floors. For the computational experiment, multi-hollow reinforced concrete floors of PC 48-12-8t with dimensions of 4780×1190 mm, thickness 220 mm and fire-retardant coating “Endotherm 210104” with an average thickness of 37 mm were selected. The heat transfer coefficient on the heated surface was assumed to be 25 W/(m<sup>2</sup>·°C), the heat transfer coefficient between the unheated floor surface and the ambient air  $\alpha_{e2}$  was assumed to depend on the temperature according to the law of free convective heat transfer from the horizontal surface, the degree of blackness of concrete was taken equal to 0.7. The thermophysical characteristics of concrete of layers 1, 3 and 5 were determined from [145], and the thermophysical characteristics of layer 2 (layer of voids with concrete bridges) were sought by solving the inverse problems of thermal conductivity. The thermophysical characteristics of the coating were set [195]: the coefficient of thermal conductivity, which depends on the temperature (**Fig. 5.6**), the specific volumetric heat capacity is constant and equal to 1.01·10<sup>6</sup> J/(m<sup>3</sup>·°C).

In test problems with the help of mathematical and computer models, given thermophysical characteristics and boundary conditions by solving direct problems of thermal conductivity, obtained non-stationary temperature distribution in fire-resistant multi-hollow reinforced concrete floor first at standard temperature, and then in the mode of the tunnel curve according to the standards of the Netherlands (RWS) and the hydrocarbon curve (**Fig. 5.7**). When solving a series

---

of direct problems of thermal conductivity, we used the limit state of the fire resistance structure to reach a critical temperature of 500 °C with reinforcement from the fire side at the specified load level in the test.

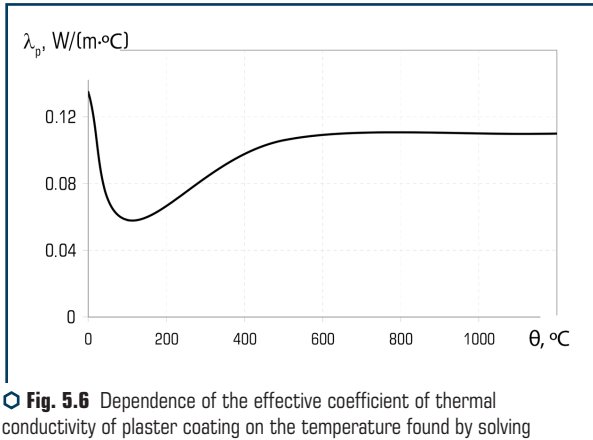

○ **Fig. 5.6** Dependence of the effective coefficient of thermal conductivity of plaster coating on the temperature found by solving the inverse problems of thermal conductivity according to fire resistance tests

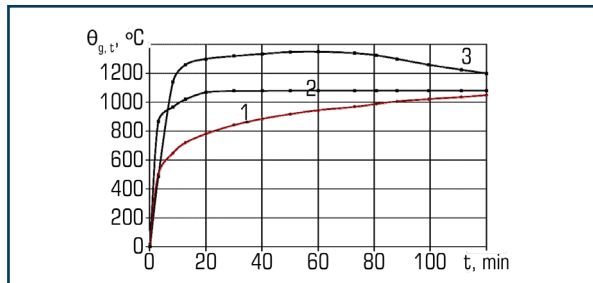

○ **Fig. 5.7** Dependence of temperature change on the duration of fire exposure in different fire modes, where: 1 – standard temperature curve according to ISO 834 and GOST 30247.0-94; 2 – hydrocarbon curve according to EN 1363-2:1999; 3 – tunnel curve according to Netherland's standards (RWS)

By solving a series of direct problems of thermal conductivity, based on the developed mathematical model of the thermal state of reinforced concrete floors, the thicknesses of fire-retardant plaster for the normalized limit of fire resistance of the floor 180 minutes (**Table 5.2**).

● **Table 5.2.** Values of the minimum thickness of the investigated plaster coating to ensure the normalized limit of fire resistance of the floor 180 minutes

Thickness of the protective layer of concrete of multi-hollow reinforced concrete floor, mm	Minimum thickness of fire-retardant coating, mm		
	Standard temperature mode	Hydrocarbon fire mode	Tunnel fire regime according to Dutch standards (RWS)
10	15.5	17.3	20
30	10.98	12.7	15.1
40	8.85	10.55	12.7
60	4.73	6.3	8.1

It was assumed that to solve direct problems of thermal conductivity to determine the characteristics of the fire-retardant capacity of the coating in hydrocarbon fire and tunnel fire according to Dutch standards (RWS), the thermophysical characteristics of fire-retardant coatings fire resistance of multi-hollow reinforced concrete floors according to the standard temperature of the fire. The dependence of the thickness of the investigated fire-retardant coating at the thickness of the protective layer of concrete 10–60 mm to ensure the normalized limit of fire resistance of the floor in 180 minutes is shown in **Fig. 5.8**.

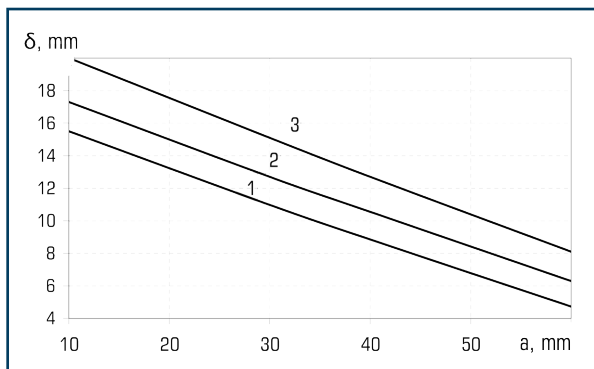

○ **Fig. 5.8** Characteristics of fire-retardant ability of the investigated plaster coating according to the criterion of reaching the critical temperature of reinforcement (500 °C) for the limit of fire resistance of 180 minutes: 1 – for standard temperature regime; 2 – for the hydrocarbon fire mode; 3 – for tunnel fire mode according to Dutch standards (RWS)

As can be seen from **Fig. 5.8**, the value of the minimum thickness of the investigated fire-retardant coating, which provides a normalized limit of fire resistance of fire-retardant multi-hollow

reinforced concrete floor, and calculated for the standard temperature of the fire, much less than the value for other temperatures. As a result, it was found that the difference between the values of the minimum required thickness of the investigated fire-retardant coating for the standard temperature regime and the temperature regime of the hydrocarbon fire is about 12 %, and the difference between the values of the required thickness of the investigated fire-retardant coating for the standard temperature regime and the temperature regime according to the standards of the Netherlands (RWS) – 29 %.

The influence of fire temperature regimes on the characteristics of fire-retardant ability of the investigated fire-retardant coating to ensure the normalized limit of fire resistance of fire-retardant multi-hollow reinforced concrete floor is determined. It was found that the required values of the minimum thickness of the coating vary from 8.1 to 20 mm for the temperature of the fire according to Dutch standards (RWS), and for the standard temperature – from 4.73 to 15.5 mm.

The reliability of the developed method for assessing the fire resistance of fire-retardant reinforced concrete structures was verified by computer simulation in the software package ANSYS R17.1. The calculation of non-stationary thermal heating of a reinforced concrete multi-hollow slab was performed, the results of which are presented in **Fig. 5.9**.

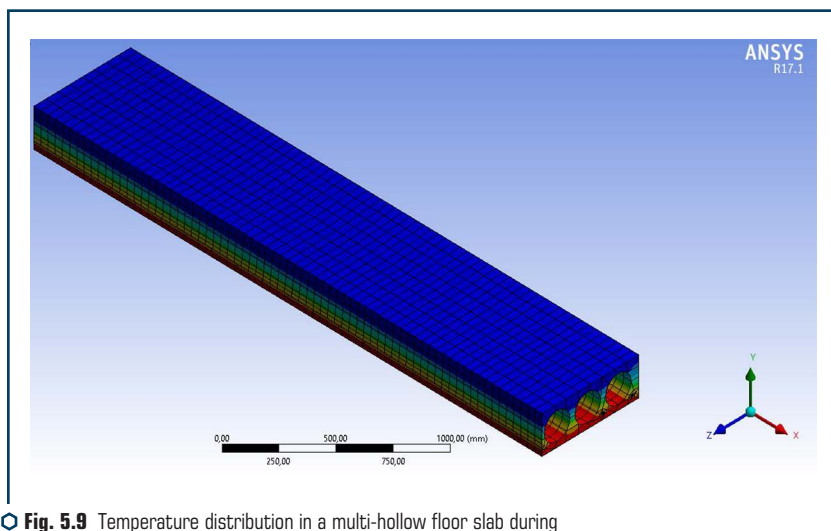

**Fig. 5.9** Temperature distribution in a multi-hollow floor slab during modelling in the ANSYS R17.1 software package

To evaluate the results of computer simulation of the thermal state of the reinforced concrete slab at temperatures corresponding to the standard temperature of the fire, a comparison of the results of experimental studies at the control points of temperature measurement (**Fig. 5.10**).

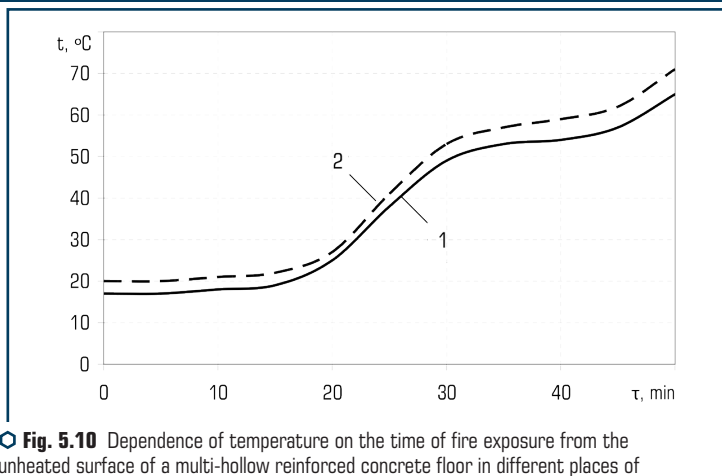

**Fig. 5.10** Dependence of temperature on the time of fire exposure from the unheated surface of a multi-hollow reinforced concrete floor in different places of temperature measurement: 1 – temperatures found during the fire resistance test; 2 – when modelling in the software package ANSYS R17.1

As can be seen from **Fig. 5.10**, the results of experimental studies and numerical analysis in the software package ANSYS (**Fig. 5.10**) for the first 15 minutes differ significantly for all control points, but later this discrepancy stabilizes, and by the end of the experiment does not exceed 10 %, which can be considered acceptable.

Thus, the developed calculation and experimental method for assessing the fire resistance of fire-retardant reinforced concrete structures, allows with sufficient accuracy for engineering calculations (up to 10 %) to assess the fire resistance of reinforced concrete structures covered with fire-retardant coatings. The proposed method allows to take into account the design features of reinforced concrete structures, temperature regimes of fires in which structures are tested, thermophysical characteristics of concrete, reinforced concrete structures, thermophysical characteristics of fire-retardant coatings, minimum thickness of fire-retardant coating to ensure normalized values.

## 5.2 VERIFICATION OF THE RELIABILITY OF THE DEVELOPED MATHEMATICAL MODEL AND CALCULATION-EXPERIMENTAL METHOD FOR ESTIMATING THE FIRE RESISTANCE OF FIRE-RETARDANT STEEL STRUCTURES

To verify the reliability of the developed calculation and experimental method for assessing the fire resistance of fire-retardant steel structures, the analysis of fire resistance tests of fire-retardant steel columns of I-beam cross section with subsequent simulation of the thermal state of columns in ANSYS software. Based on the comparison of experimental and calculated data, a conclu-

sion was made about the adequacy of the developed method and the allowable areas of deviation in the assessment of fire resistance of fire-retardant steel structures using this method [241, 228].

Two steel columns of I-beam section NEB 200 (thickness 6.1 mm), 2 m high were tested. The columns were treated with “Amotherm Steel Wb” fire retardant substance after preliminary application of GF-021 primer. Three thermocouples were placed on each sample.

The fire retardant was applied by mechanization and manually. The average coating thickness was 2.927 mm. The experiment was performed at an air temperature of 27 °C, relative humidity of 54 %. The average thickness of the coating of fire-retardant “Amotherm Steel Wb” (dry state without coat) was 2.928 mm on sample N<sup>o</sup> 1 and 2.925 mm on sample N<sup>o</sup> 2.

The temperature regime in the furnace was reproduced according to the standard temperature regime of the fire (**Fig. 5.11**).

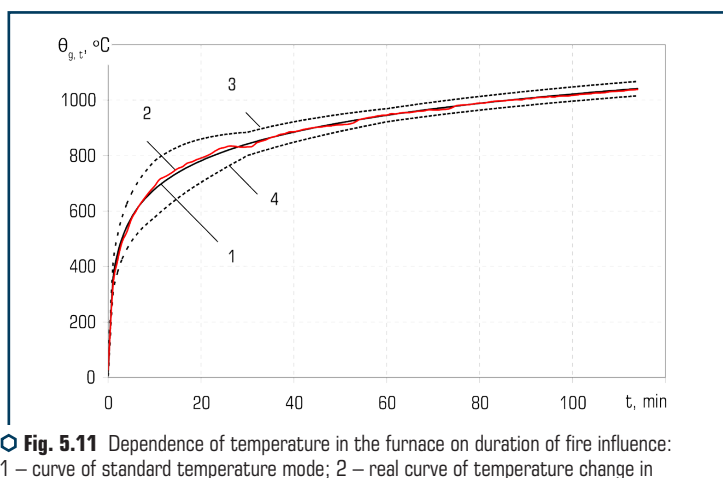

**Fig. 5.11** Dependence of temperature in the furnace on duration of fire influence: 1 – curve of standard temperature mode; 2 – real curve of temperature change in the furnace; 3 – the maximum values of temperature in the furnace are admissible at tests; 4 – the minimum values of temperature in the furnace are admissible at tests

The dependence of the average temperatures of the samples of steel columns with the studied fire-retardant coating on the time of fire exposure to the standard temperature of the fire is shown in **Fig. 5.12**.

Shown in **Fig. 5.12** temperature dependences were compared with the results of computer simulation of non-stationary heating of a steel column with a fire-retardant coating, performed using the software ANSYS R17.1. For comparison, we used the dependences of the average temperatures of the column N<sup>o</sup> 2 (**Fig. 5.12**, curve 2), which warmed up the most as a result of the test.

Thermophysical characteristics of the studied fire-retardant coating for use in calculations of non-stationary heating of fire-retardant steel column were determined in [225]: coefficient of thermal conductivity (**Fig. 5.13**) and constant value of specific volumetric heat capacity  $1 \cdot 10^5 \text{ J/m}^3 \cdot \text{°C}$ .



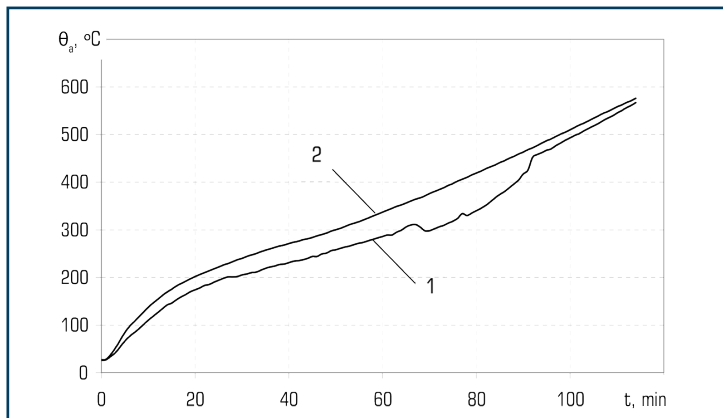

○ **Fig. 5.12** Dependence of average temperatures of samples of steel columns with fire-retardant coating "Amotherm Steel Wb" on the time of fire exposure to the standard temperature of the fire: 1 – sample column № 1; 2 – sample column № 2

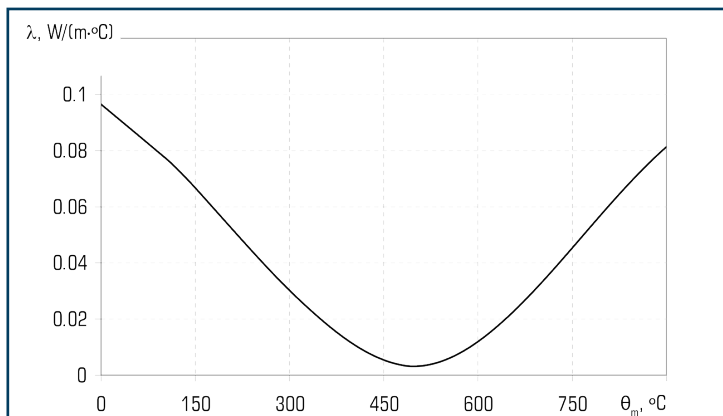

○ **Fig. 5.13** Dependence of the effective thermal conductivity of the coating "Amotherm Steel Wb" on the temperature found by solving the inverse problems of thermal conductivity

The geometric dimensions of the column for modelling its thermal state are shown in **Fig. 5.14** and in **Table 5.3**.

The computer model of the thermal state of the studied fire-retardant column was built on the basis that the column is heated in the furnace on four sides equally. Therefore, each surface of the column is considered as a two-layer system consisting of a layer of steel and a layer of

fire-retardant coating of appropriate thickness. This model allows you to calculate the temperature distribution at all spatial points of the layers over time and at the location of thermocouples not only on the standard temperature of the fire, but also on other alternative fire modes.

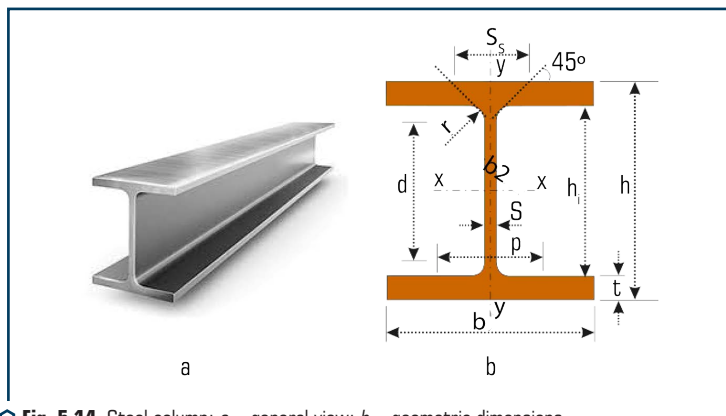

Fig. 5.14 Steel column: a – general view; b – geometric dimensions

Table 5.3 Geometric dimensions of the steel column NEV 200 for modelling its non-stationary heating in the software environment ANSYS R17.1

Nominal weight 1 m, kg/m	Dimensions, mm					Cross-sectional area $A$ , cm <sup>2</sup>	Dimensions for detailing, mm				
	$b$	$h$	$s$	$t$	$r$		$h_1$	$d$	$\varnothing$	$e_{\min}$	$e_{\max}$
61.3	200	200	9	15	18	78.1	170	134	M27	100	100

Therefore, it is proposed to verify the reliability of the developed method for assessing the fire resistance of fire-resistant steel structures on samples of reduced size in the form of steel plates covered on one side with a fire-retardant substance (Fig. 5.15).

The reliability of any calculation largely depends on the accuracy of setting the parameters of the model that ensure its adequacy to the real processes of heat transfer in fire resistance tests. Among the parameters of the model, it is necessary to identify those that are unknown or insufficiently known and have the greatest impact on the calculated values of temperatures of the selected model. Such parameters for fire-retardant steel structures include the coefficient of thermal conductivity and the specific volumetric heat capacity of the coating under study.

When conducting a real experiment, there are measurement errors, which are taken into account in the computational experiment by introducing into the temperature values of artificial errors of a random nature, corresponding to the level of real measurement errors. The inverse

problems of thermal conductivity are solved both on “accurate” temperature values (excluding errors of experimental measurements) and on “perturbed” temperature values to show the influence of random components of measurement errors on the accuracy of model parameters. Influence of systematic components of measurement errors – the issue is difficult in the practice of real measurements, their consideration is also possible in computational experiment and analysis of identified parameters, but in this paper this issue was not considered.

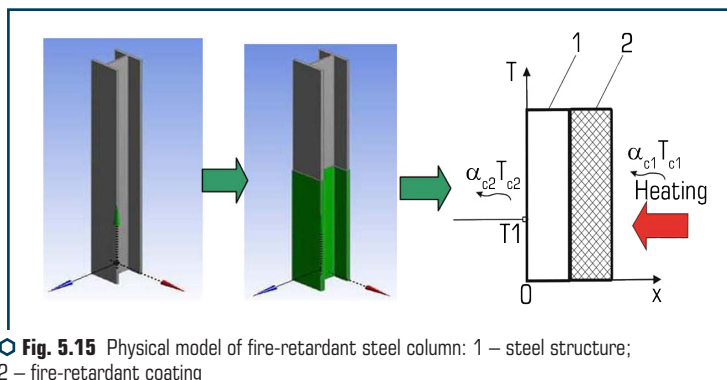

Fig. 5.15 Physical model of fire-retardant steel column: 1 – steel structure; 2 – fire-retardant coating

The identification of parameters means a procedure that shows, firstly, the fundamental possibility of finding the parameters by solving the inverse problems of thermal conductivity, and secondly, if they are, then with what error. The inverse problems ensure the finding of such values of the model parameters, which give the proximity of experimental and calculated values of temperatures at the measuring points of the studied fire-resistant steel structures. The analysis of the identified model parameters is usually performed by solving test problems in which the values of temperatures at the predicted measurement points are determined from a computational experiment (calculation of temperatures at given model parameters, solving direct problems).

In test tasks with the help of the model, given thermophysical characteristics and boundary conditions by solving direct problems of thermal conductivity, non-stationary temperature distribution in a steel structure with  $T(t)$  coating is obtained. Then the points of the obtained dependence are perturbed, simulating errors in temperature measurement, and these dependences  $T(t) \pm \delta$  determine the thermophysical characteristics and boundary conditions, which are then compared with the specified ones. This makes it possible to study the algorithm for determining the thermophysical characteristics and boundary conditions with the required accuracy, as well as to establish the required number of samples to determine the parameters of the model and the dependence of coating thickness on the thickness of steel structure.

In this section, a study of the effect of errors of 10 and 20 % in measuring the temperature from the unheated surface of the fire-retardant steel structure on the accuracy of determin-

ing the thermophysical characteristics of the coating under study [241, 228]. Random errors of 10 and 20 % in the measurement of temperatures from the unheated surface of the fire-retardant steel structure using a random number generator were introduced (**Fig. 5.16, 5.17**).

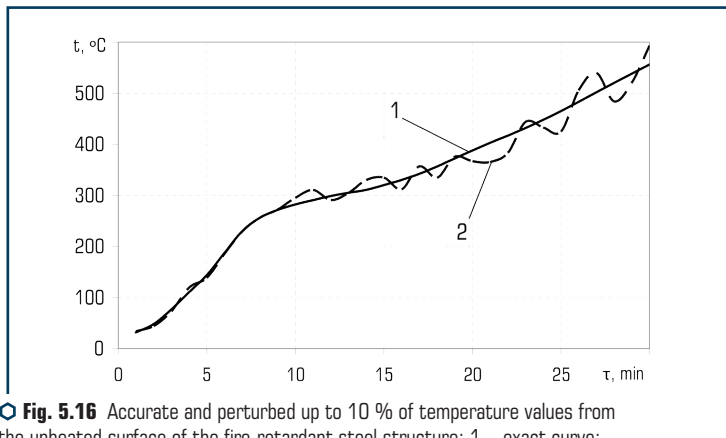

○ **Fig. 5.16** Accurate and perturbed up to 10 % of temperature values from the unheated surface of the fire-retardant steel structure: 1 – exact curve; 2 – perturbed by 10 % curve

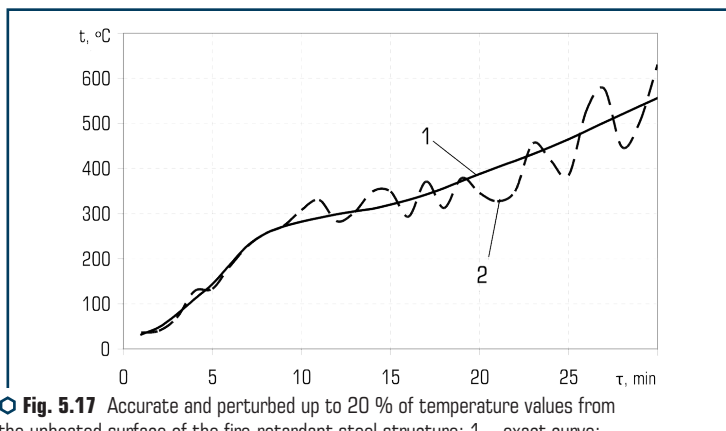

○ **Fig. 5.17** Accurate and perturbed up to 20 % of temperature values from the unheated surface of the fire-retardant steel structure: 1 – exact curve; 2 – perturbed by 20 % curve

The obtained perturbed values of temperatures by 10 % were used in finding the thermophysical characteristics of the fire-retardant coating under study, solving the inverse problems of thermal conductivity (**Fig. 5.18**).

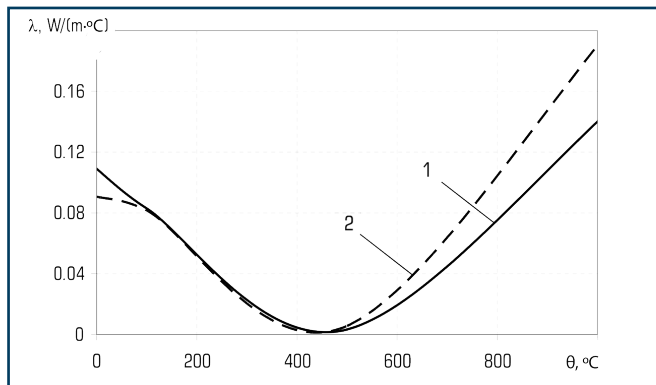

○ **Fig. 5.18** Dependence of the effective coefficient of thermal conductivity of fire-retardant coating on temperature, where: 1 – exact coefficients; 2 – coefficients obtained by solving the inverse problems of thermal conductivity at perturbed temperatures by 10 %

The criterion of standard deviation when searching for the coefficient of thermal conductivity of the fire-retardant coating of a well-known Italian company for temperatures disturbed by 10 % was 18.6 °C. The exact and calculated temperatures from the unheated surface of the fire-retardant steel structure are shown in **Fig. 5.19**.

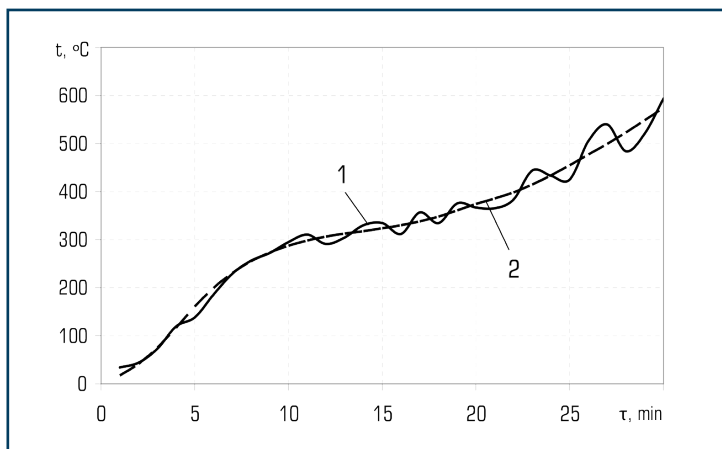

○ **Fig. 5.19** Experimental and calculated values of temperatures from the unheated surface of the fire-retardant steel structure during their perturbation by 10 %: 1 – experimental curve; 2 – calculated curve

The obtained perturbed values of temperatures by 20 % were used in finding the thermo-physical characteristics of the fire-retardant coating under study, solving the inverse problems of thermal conductivity (Fig. 5.20).

The criterion of standard deviation in the search for the coefficient of thermal conductivity of the fire-retardant coating of a well-known Italian company for perturbed temperatures of 20 % was 37.03 °C. Exact and calculated temperatures from the unheated surface of the fire-retardant steel structure are shown in Fig. 5.21.

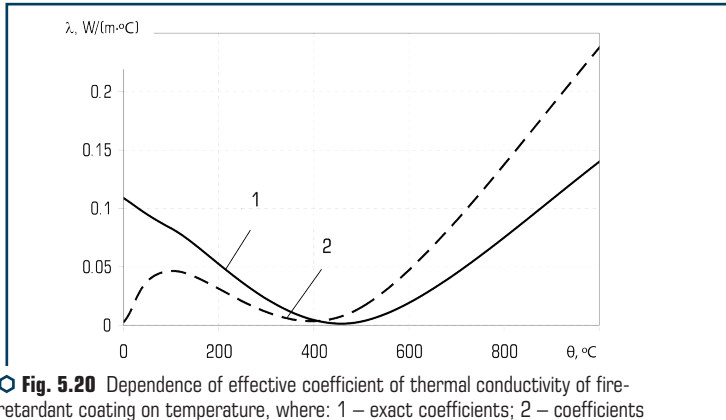

Fig. 5.20 Dependence of effective coefficient of thermal conductivity of fire-retardant coating on temperature, where: 1 – exact coefficients; 2 – coefficients obtained by solving the inverse problems of thermal conductivity at perturbed temperatures by 20 %

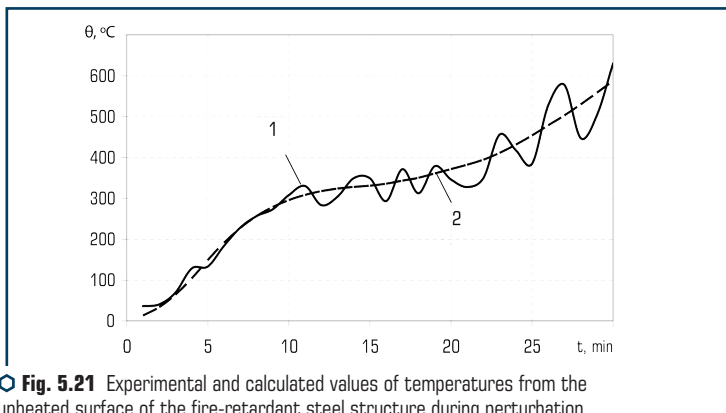
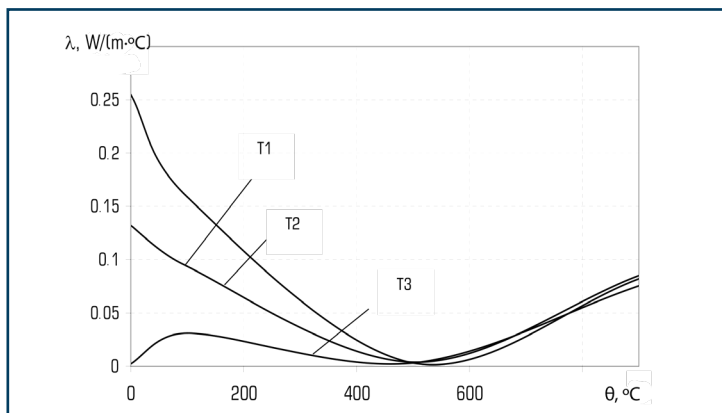

Fig. 5.21 Experimental and calculated values of temperatures from the unheated surface of the fire-retardant steel structure during perturbation by 20 %: 1 – exact curve; 2 – calculated curve

Thus, the study found that random errors in measuring temperatures of 10 and 20 % of the unheated surface of the fire-retardant steel structure significantly affect the accuracy of determining the thermophysical characteristics of the coating to protect steel structures. This indicates the need to take them into account when designing buildings and structures. Inaccuracy in measuring temperatures from the unheated surface of the fire-retardant steel structure in 10 % leads to an error in determining the thermophysical characteristics of the coating in 17 %, and in 20 % – to errors in 34 %. Based on the developed model, the thermophysical characteristics of the coating were determined according to the readings of one thermocouple in the appropriate location (T1, T2, T3) [225] (**Fig. 5.22**).

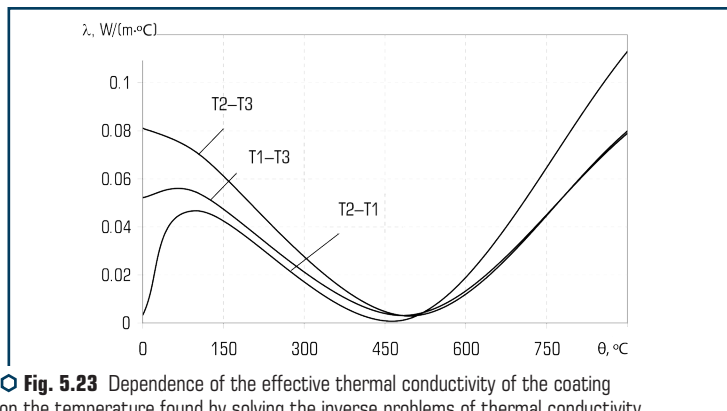

**Fig. 5.22** Dependence of the effective coefficient of thermal conductivity of the investigated coating on the temperature found by solving the inverse problems of thermal conductivity: T1 – by thermocouple located at a distance of 100 mm from the upper edge of the fire-retardant plate; T2 – according to the thermocouple located in the center of the fireproof plate; T3 – according to the thermocouple located at a distance of 100 mm from the lower edge of the flame retardant plate

As can be seen from **Fig. 5.22**, the values of the effective thermal conductivity of the coating in the temperature range from 20 to 500 °C are very different, due to two factors: heterogeneity of heat flux affecting the steel structure, and heterogeneity of coating thickness in different places of temperature measurement. This indicates the impossibility of determining the thermophysical characteristics of the coating only based on one thermocouple, due to large errors in the value of the effective thermal conductivity, which leads to errors in determining the fire-retardant capacity of the studied coating.

Therefore, further research was aimed at determining the thermophysical characteristics of the coating by the values of two thermocouples in different combinations: T1–T2, T2–T3, T1–T3.

As a result, the dependences of the effective thermal conductivity of the studied coating on the temperature for these combinations were obtained (**Fig. 5.23**).



**Fig. 5.23** Dependence of the effective thermal conductivity of the coating on the temperature found by solving the inverse problems of thermal conductivity on the indicators of two thermocouples in different combinations

As can be seen from **Fig. 5.23**, the curve of the effective thermal conductivity of the coating found by solving the inverse problems of thermal conductivity on the indicators of two thermocouples T2–T3 and T1–T3 are almost the same, and on the indicators of thermocouples T2–T1 differs from initial temperature to 100 °C, which could be explained by intense heating the upper part of the steel plate due to the effect of “sliding” of the coating during the test and the appearance of the bare surface of the steel plate [270].

In **Fig. 5.24** presents the calculated and experimental temperatures from the unheated surface of the fire-retardant structure. There is a satisfactory coincidence of temperature values, for which the standard deviation criterion was: for T2–T3 – 6.3 °C, T1–T3 – 6.7 °C, T2–T1 – 14.3 °C.

The maximum discrepancy between the calculated and experimental values of temperature (**Fig. 5.24, a**) was about 3 %, and in **Fig. 5.24, b** – 8 %.

Therefore, in the future to determine the thermophysical characteristics of the coating used indicators of three thermocouples installed from the unheated surface of the fire-retardant steel structure (**Fig. 5.25**).

As can be seen from **Fig. 5.25**, in the temperature range from the initial temperature of about 500 °C the value of the thermal conductivity of the coating decreases linearly and passes through the minimum value of 0.003 W/m·°C (at 500 °C), which can be explained by physicochemical processes in the coating: swelling of the coating and increase its porosity.

The increase in the thermal conductivity in the temperature range from 500 °C to 800 °C is due to the appearance of the radiation component in the pores of the coating in combination with



its high-temperature shrinkage and charring. The constant value of the specific volumetric heat capacity was  $C_v = 1 \cdot 10^5 \text{ J/m}^3 \cdot ^\circ\text{C}$ .

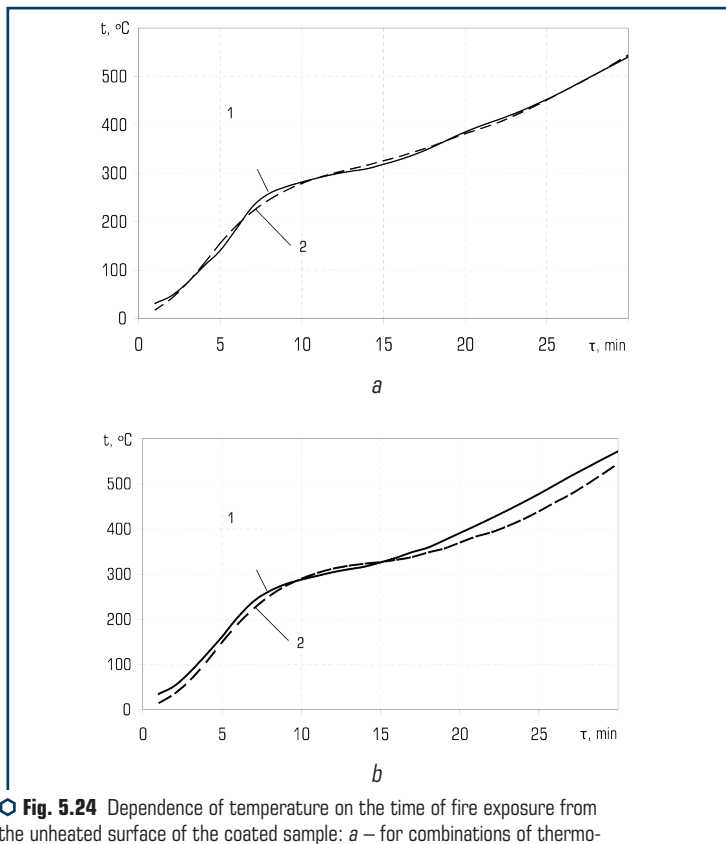

**Fig. 5.24** Dependence of temperature on the time of fire exposure from the unheated surface of the coated sample: *a* – for combinations of thermocouples T2–T3 and T1–T3; *b* – for combinations of thermocouples T2–T1; 1 – experimental curve; 2 – calculated curve

The greatest convergence of experimental and calculated temperatures was observed, and the criterion of standard deviation was  $5.8 \text{ }^\circ\text{C}$ .

A further increase in the number of thermocouples installed from the unheated surface of the steel plate did not lead to a decrease in the root mean square deviation criterion.

To verify the reliability of the developed method, a calculated finite-element model of the system “steel plate – fire-retardant coating” was developed for modelling non-stationary heating

of such a system in the software package ANSYS. The obtained calculated data (temperature from unheated surface of fire-resistant steel structure) were also compared with the results of experimental study of heating of such structures during tests in fire furnace both at standard fire temperature and at hydrocarbon fire temperature [240, 223].

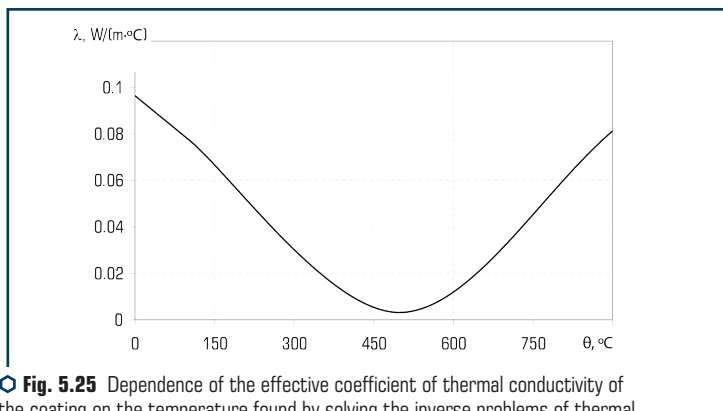

**Fig. 5.25** Dependence of the effective coefficient of thermal conductivity of the coating on the temperature found by solving the inverse problems of thermal conductivity, according to the indicators of three thermocouples

Thermophysical characteristics were determined based on the basic model of calculation by the method of successive iterations to obtain convergence of the calculated and experimental data of heating of the experimental samples not more than 10 %.

When solving the thermal problem, the dependence of the steel plate temperature on the time of fire exposure according to the standard temperature of the fire was determined and the developed mathematical model of the thermal conductivity process in one-dimensional non-linear formulation was used.

The specific heat capacity of steel  $c_s$  (J/(kg·°C)) and thermal conductivity of steel  $\lambda_s$  (W/(m·°C)) were set from [233].

The Poisson's ratio of steel was set  $\nu=0.3$ , the modulus of elasticity of steel –  $E_s=2.1 \cdot 10^5$  MPa.

The model of the thermal state of the system “steel structure – fire-retardant coating” in case of fire is non-stationary and considers radiation-convective heat exchange in the gaseous medium from the heat source (fire) to the surface of the fire-resistant steel structure, heat transfer structures into the environment from the unheated surface.

Calculations of steel temperature according to this mathematical model were performed using the numerical method of solving the implicit finite-difference approximation scheme.

The condition of perfect thermal contact was accepted between the joints of the structure and the fire-retardant coating.

The computer model was created based on geometric, physical and mathematical models by generating a computational grid. In **Fig. 5.26** shows a fragment of a grid model as part of a computer model.

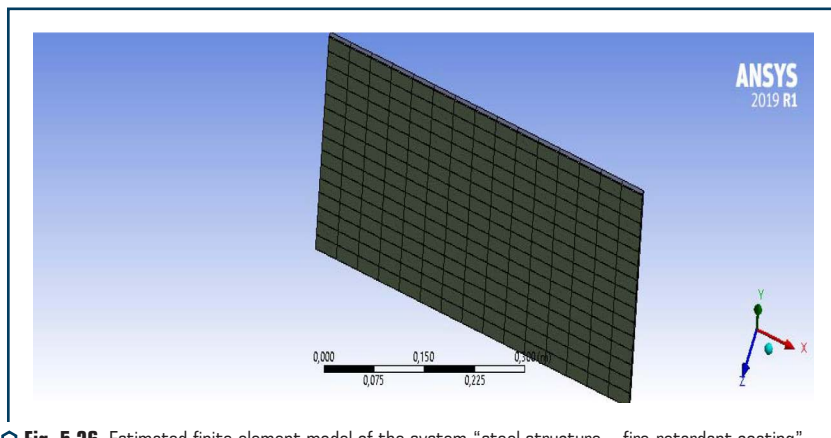

**Fig. 5.26** Estimated finite element model of the system “steel structure – fire-retardant coating”

The grid model (**Fig. 5.26**) is made with the necessary thickening to consider the peculiarities of heat transfer in places of large temperature gradients near the surface exposed to fire, as well as on the contact surfaces of steel plate with fire-retardant coating. Boundary conditions and nonlinear thermophysical properties of materials were set.

In **Fig. 5.27** shows the calculations of non-stationary heating of the fire-retardant system in the form of a steel plate with a fire-retardant coating in the ANSYS software package using the calculated finite-element model of this system (**Fig. 5.26**).

The obtained temperature numerical simulations were compared with the data of experimental determination of the temperature of steel structures with fire-retardant coating under fire conditions at standard fire temperature, first for the minimum value of fire-retardant coating thickness (0.248 mm) and then for maximum coating thickness (1.288 mm). In the future, also for different values of the heat transfer coefficient by convection and thermal radiation on the unheated surface of the steel structure (5 and 9 (W/(m<sup>2</sup>·°C))) (**Fig. 5.28, 5.29**).

The obtained calculated data of the dependence of the temperature from the unheated surface of the steel structure with a fire-retardant coating on the time of fire exposure to the standard temperature of the fire, compared with the results of the experimental study. Satisfactory convergence of experimental and calculated temperatures was established, and the maximum calculation error was 7 % [223].

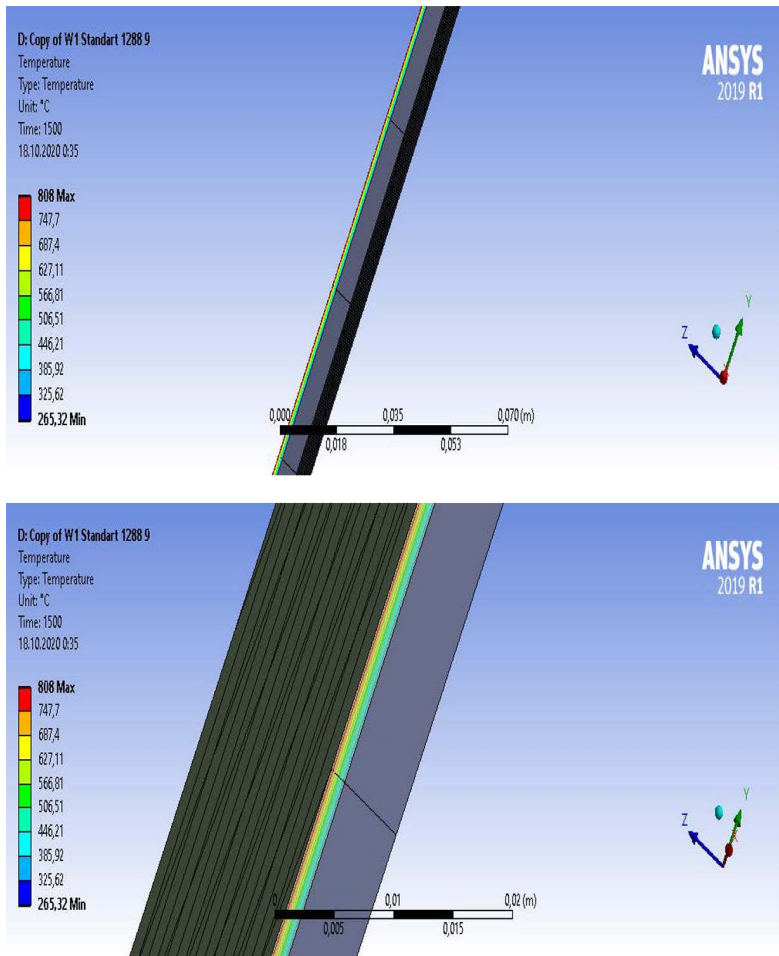

○ Fig. 5.27 Temperature distribution in the model “steel structure-fire-retardant coating with maximum thickness” after 25 minutes of testing under conditions of standard fire temperature

The influence of the coefficient of heat transfer by convection and thermal radiation from the unheated surface of a steel structure with a fire-retardant coating on the accuracy of modelling the thermal processes occurring under fire at the standard temperature of the fire is investigated. For this purpose, simulation of non-stationary temperature heating of a steel plate with a fire-retardant coating with a maximum value of the coating thickness of 1.288 mm at different values of

the convection heat transfer coefficient was performed in the ANSYS software environment and thermal radiation on the unheated surface of the steel plate (5 and 9 W/(m<sup>2</sup>·°C)). The results of numerical simulations are presented in **Fig. 5.29**.

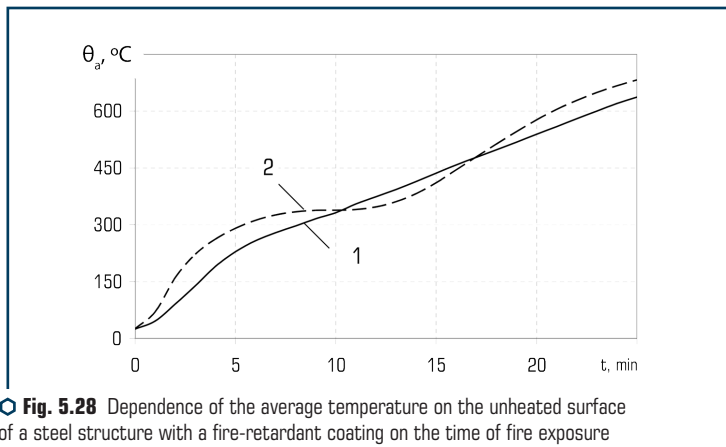

**Fig. 5.28** Dependence of the average temperature on the unheated surface of a steel structure with a fire-retardant coating on the time of fire exposure according to the standard temperature of the fire (minimum value of the coating thickness): 1 – obtained experimentally; 2 – obtained by simulation in ANSYS

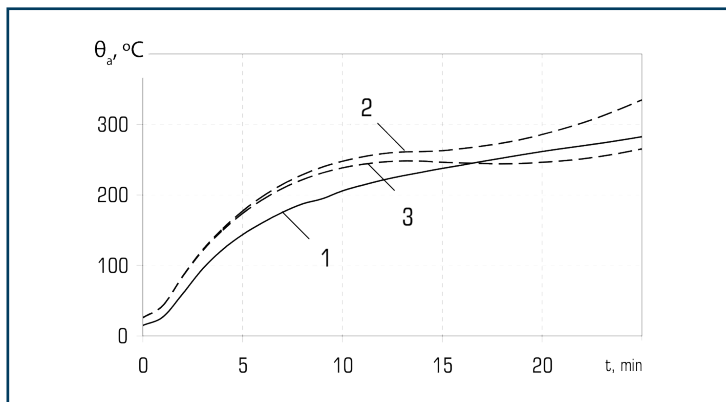

**Fig. 5.29** Dependence of the average temperature on the unheated surface of a steel plate with a fire-retardant coating (maximum thickness) on the time of fire exposure to the standard temperature of the fire: 1 – obtained experimentally; 2 – obtained by simulation in ANSYS (heat transfer coefficient from the unheated surface of a steel structure with a coating of 5 W/(m<sup>2</sup>·°C)); 3 – obtained by simulation in ANSYS, the heat transfer coefficient on the unheated surface of a steel plate with a coating of 9 W/(m<sup>2</sup>·°C)

As can be seen from **Fig. 5.29**, the best convergence of the results of computer modelling is observed when setting such a parameter of the model as the heat transfer coefficient on the unheated surface of a steel plate with a coating equal to  $5 \text{ W}/(\text{m}^2 \cdot ^\circ\text{C})$ . The maximum calculation error was 8 %.

The results obtained because of the work, namely: heating temperatures of fire-retardant samples of steel structures at standard fire temperatures, as well as temperatures obtained by modelling non-stationary heating in the ANSYS software are well correlated and have satisfactory convergence. This is due to the use of known mathematical models of heat transfer for the system “steel structure – fire-retardant coating”, proven numerical methods of integrating mathematical models of heat transfer and solving inverse thermal conductivity problems, as well as satisfactory coincidence of calculated and experimental temperatures in tested fire-resistant steel structures. The proposed approach on samples of reduced size allows to reduce labour costs, reduce research time, and allows a more accurate approach to assessing the fire-retardant ability of reactive coatings of steel structures of different types and profiles. In comparison with the existing approaches (tests for fire resistance of the structure, the estimated determination of the fire resistance of fire-retardant steel structures), the proposed approach has features, which consist in the development of a finite element model of the system “steel structure – fire-retardant coating” and comparison of the results with experimental studies on samples of reduced size. This approach is used to assess the fire resistance of coatings of steel structures. With the help of the constructed calculated finite element model it is possible to perform calculations to determine the time of reaching the critical temperature of the steel structure and reactive flame retardant coating of different thickness.

### 5.3 DEVELOPMENT OF AN INSTALLATION FOR DETERMINING THE ADHESIVE STRENGTH OF COATINGS OF FIRE-RETARDANT STEEL STRUCTURES

The disadvantage of most fire-retardant coatings is poor adhesion to the surface to be protected. Therefore, the study of the adhesive strength of fire-resistant steel structures is proposed to be carried out on a specially designed installation.

The adhesive strength of the joint “film fire-retardant coating – steel structure” could be determined by the method of swelling of the film, which belongs to the side method of determining the adhesive strength (**Fig. 5.30**). In this work, this method is implemented using the action of compressed oxygen [246].

For this purpose, a hole was drilled in the plate. The area of the film separation and the gas pressure that must be created for its separation were determined. The gas pressure is distributed in all directions evenly. Therefore, the detachment of the film occurs under the action of a force directed at different angles on the contact area of the film. When the film swells, part of the gas is spent on deforming the film.

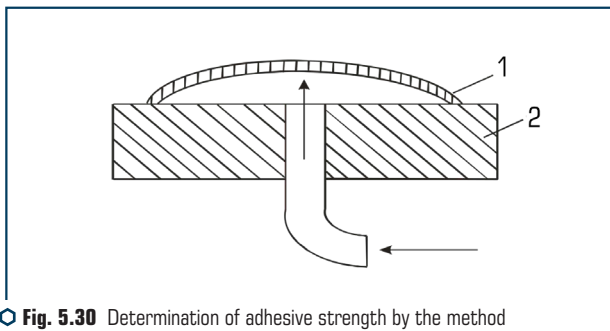

○ **Fig. 5.30** Determination of adhesive strength by the method of swelling of the film: 1 – adhesive; 2 – substrate

Using this method, an installation was developed to determine the adhesive strength of fire-retardant coatings (**Fig. 5.31**), which consists of an oxygen supply mechanism of oxygen-insulating gas mask KIP-8, a cylinder of compressed oxygen, volume 1 liter at a pressure of  $190 \text{ kgf/cm}^2$ , a metal cylinder through which oxygen is supplied and a metal plate made of steel MS-17 for applying a flame retardant. Oxygen supply mechanism adjusted to the supply of  $1.4 \text{ l/min}$  oxygen at a pressure of  $4.5\text{--}5.6 \text{ kgf/cm}^2$ . The oxygen supply mechanism, in this case, serves as a reducer, which converts high-pressure ( $190 \text{ kgf/cm}^2$ ) into low-constant ( $4.5\text{--}5.6 \text{ kgf/cm}^2$ ).



○ **Fig. 5.31** Installation for determining the adhesive strength of coatings of fire-retardant steel structures

The following equipment and materials were used for the test. Installation for determining the adhesive strength of fire-retardant coatings (**Fig. 5.32**) consists of: an oxygen cylinder with a shut-off valve with a capacity of 1 liter and an initial pressure of  $20 \text{ MPa}$ ; oxygen supply mechanism of KIP-8 gas mask; small standard manometer with capillary tube; an air pipe connecting the oxygen supply mechanism and the working plate; working plate with a hole diameter of  $10 \text{ mm}$ .

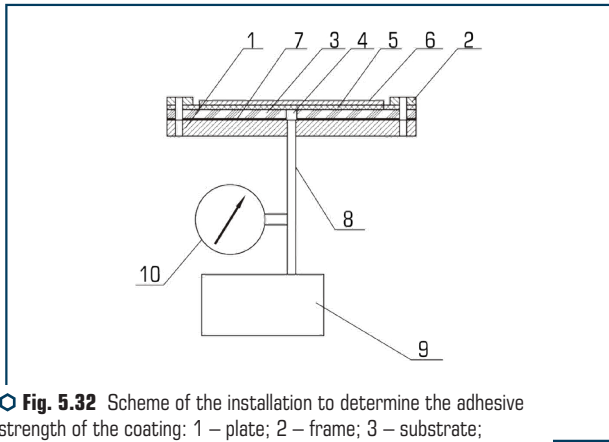

**Fig. 5.32** Scheme of the installation to determine the adhesive strength of the coating: 1 – plate; 2 – frame; 3 – substrate; 4 – hole; 5 – coverage; 6 – safety cover; 7 – seals; 8 – fitting; 9 – compressed gas supply mechanism; 10 – manometer

The use of compressed gas as a working medium allows to simplify the design of the node that clamps the sample, and thus increase the manufacturability of the device as a whole.

The seal on the bottom plate eliminates the leakage of compressed gas at the boundary between the plate and the substrate and ensures the reliability of the device.

In addition, the use of a manometer as a recording device provides a convenient fixation of the indicator to determine the adhesive strength of the coating.

Installation for determining the adhesive strength of the coating includes a plate 1 and a frame 2, clamping the sample, which consists of a substrate 3 having a hole 4, a coating 5 and a safety pad 6. Between the plate 1 and the substrate 3 is a seal 7. On the plate 1 installed fitting 8, to which the compressed gas supply mechanism 9 and the manometer 10 are connected.

The adhesive strength of the coating is determined by the magnitude of the tear load and the area of separation of the coating.

The operation of the installation is as follows: the prepared sample is clamped between the plate 1 and the frame 2 so that the hole 4 of the substrate 3 is coaxial with the fitting 9. Preparation of the sample is as follows: the substrate 3 with the hole 4 complete hardening, glue the safety pad 6, the area of which is less than the inner area of the frame, and along the perimeter of the safety pad 6 cut the coating 5 to the substrate 4. Then test the adhesive strength of the coating. To do this, the compressed gas supply mechanism 10 through the fitting 9 supplies pressurized gas through a hole 4 in the substrate 3 to the interface, which separates the coating 5 from the substrate 3.

The adhesive strength of the coating is determined by the pressure on the manometer 11 at the time of separation of the coating 5 and the area of separation. The area of separation of the coating  $S_1$  is calculated by the parameters  $S$ ,  $S_{obv}$ , which are determined during sample preparation.



The adhesive strength of the coating is calculated by the formula:

$$F = P_{pov} \cdot S_{otv}; P_a = F \cdot S_1 = F \cdot (S - S_{otv}), \quad (5.2)$$

where  $F$  – the force of pressure on the adhesive coating;  $P_a$  – adhesive strength of the coating;  $P_{pov}$  – gas pressure;  $S$  – the area of a covering under a safety overlay;  $S_{otv}$  – the area of the hole in the substrate;  $S_1$  – coverage of separation area.

#### 5.4 VERIFICATION OF THE RELIABILITY OF THE INSTALLATION TO DETERMINE THE ADHESIVE STRENGTH OF COATINGS OF FIRE-RETARDANT STEEL STRUCTURES

Steel plates  $90 \pm 1$  mm long,  $60 \pm 3$  mm wide and a 10 mm diameter hole in the center were prepared for the test to determine the adhesive strength of the coating. Fire-retardant compositions were applied to the prepared samples and left to harden completely. An installation for determining the adhesive strength was assembled. The suitability of the installation for work was checked by visually checking the integrity of the system and its tightness [246].

Steel plates with formed coatings were attached to the working surface of the installation. Polyvinyl acetate was used to ensure the density between the sample and the work surface. The compressed oxygen cylinder was opened and the pressure in the system was gradually increased by means of an oxygen supply mechanism. After the data were obtained, similar tests were performed with other samples. After each test, the work surface was cleaned of polyvinyl acetate residues. The test results are given in **Table 5.4**.

● **Table 5.4** Test results of coatings for adhesive strength

Nº	Coating	Type of surface to be protected	System pressure, MPa	Surface area, cm <sup>2</sup>	Adhesion index, MPa/cm <sup>2</sup>
1	Composition Nº 1	steel	10	3.10	≥3.2
2	Composition Nº 2	steel	10	3.14	≥3.2
3	Composition Nº 3	steel	10	3.08	≥3.2

According to the results of studies to determine the adhesive strength of manufactured coatings, all coatings have adhesion to the steel surface of more than 3 MPa/cm<sup>2</sup>. That is, at a pressure in the system of 10 MPa, no separation of the coating film from the steel surface was observed – the adhesion of the coatings is very high.

Comparing the indicators of adhesive strength to the steel surface with similar indicators of known fire-retardant compositions, it can be seen that the studied compositions in these properties are not inferior to standardized fire-retardant coatings.

## CONCLUSIONS ON THE SECTION 5

1. The reliability of the developed mathematical model and calculation-experimental method for estimating the fire resistance of fire-retardant reinforced concrete structures using the method of computational experiment, which determined the permissible errors. It was found that random errors of 10 % when measuring temperatures from the unheated surface of the fire-retardant floor significantly affect the accuracy of determining the thermophysical characteristics of the coating (maximum error up to 30 %).

To analyze the sensitivity of the proposed model, a technique was used, which consists in sequential perturbation of model parameters, identification of thermophysical characteristics of fire-retardant coatings and solving a series of direct problems of thermal conductivity. As a result, it is established that the greatest influence on the accuracy of fire resistance of fire-retardant reinforced concrete structures have such parameters of the mathematical model as the coefficient of thermal conductivity of fire-retardant coating and specific volumetric heat capacity of reinforced concrete floor. The influence of the heat transfer coefficient between the unheated floor surface and the environment in assessing the fire resistance of fire-retardant multi-hollow reinforced concrete floors on the accuracy of determining the thermophysical characteristics of the fire-retardant coating.

2. The reliability of the developed mathematical model and calculation-experimental method for estimating the fire resistance of fire-retardant steel structures is verified. Accidental errors in measuring temperatures of 10 and 20 % from the unheated surface of a fire-retardant steel structure have been found to significantly affect the accuracy of thermophysical characteristics of the coating to protect steel structures and must be taken into account when designing buildings and structures. Inaccuracy in measuring temperatures from the unheated surface of the fire-retardant steel structure by 10 % leads to an error in determining the thermophysical characteristics of the coating at 17 %, and for 20 % – the error was 34 %.

3. The calculated finite-element model of the system “steel plate – fire-retardant coating” for modelling non-stationary heating of such a system in the ANSYS software package is developed. Using this model, calculations of the thermal state of the steel plate with a minimum thickness of the fire-retardant coating of 0.248 mm were performed. Satisfactory convergence of experimental and calculated temperatures has been established. The maximum calculation error was 7 %. The use of the developed finite element model of the system “steel plate – fire-retardant coating” will further calculate the non-stationary heating of steel structures of all types in the range of thicknesses, cross-sectional factors, design temperatures and fire resistance classes in the ANSYS software package with sufficient accuracy for engineering calculations (up to 10 %). The results of numerical simulation of non-stationary heating of the system “steel structure – fire-retardant coating” with a maximum coating thickness of 1.288 mm in the ANSYS software package were verified. It is established that the results of experimental studies and numerical analysis are positively correlated with each other within the allowable error of no more than 8 %.

---

4. An installation for determining the adhesive strength of fire-retardant coatings for the protection of steel structures has been developed. The reliability and operability of the proposed installation were tested on the example of the study of the adhesive strength of three fire-retardant coatings. It was found that all coatings have high adhesion to the steel surface (more than 3 MPa/cm<sup>2</sup>). That is, at a pressure in the system of 10 MPa, no separation of the coating film from the steel surface was observed.

## CONCLUSIONS

1. Analysis of the current state of fire safety of buildings and structures of industrial and civil construction showed the presence of contradictions that arise in the analysis of the conditions for fire resistance of fire-retardant building structures. Resolving these contradictions creates conditions for the safe operation of buildings and structures using fire-retardant reinforced concrete and steel structures with scientifically sound parameters of their fire-retardant coatings. Based on the analysis, it is established that ensuring the normalized value of the limit of fire resistance of load-bearing elements of reinforced concrete and steel building structures is an important and quite complex problem, the solution of which will allow at the design stage, construction and operation of buildings and structures of industrial and civil construction to use in modern construction building structures that are able to provide buildings or structures with resistance to high temperature or destruction due to disruption of the normal cycle of the object.

2. Experimental methods for assessing the fire resistance of fire-retardant steel and reinforced concrete structures are the most accurate and provide the most reliable information on the limits of fire resistance of building structures in terms of their testing at standardized fire temperatures. However, along with the advantages of such methods have several disadvantages. Such shortcomings include: the complexity of manufacturing, preparation and testing of fire resistance of large building structures, high material costs for testing in accredited laboratories. Disadvantages include the inability to transfer the test results of one structure to structures of all sizes and types, poor adhesion of fire-retardant coating to the protected surface during fire, the problem of maintaining the integrity of the fire-retardant coating, and as a consequence, failure to perform its protective functions. All this imposes some restrictions on the use of only the experimental method of assessing the fire resistance of fire-retardant steel and reinforced concrete structures in view of the above shortcomings. The use of calculation methods to assess the fire resistance of unprotected and fire-retardant steel and reinforced concrete building structures, compared to the experimental, has a number of advantages, such as the ability to perform calculations without high material costs, although software products must be certified, which could be expensive, and highly qualified specialists who will be able to correctly and reasonably set the parameters of the model of the thermal state of fire-resistant building structures. After all, inaccuracies in setting initial, boundary conditions and inaccuracies in the use of mathematical and physical models of thermal processes in fire-resistant structures under fire, could lead to erroneous assessment of fire resistance of fire-resistant building structures, and thus to miscalculations in the design of buildings and structures.

3. As a result of the work, physical and mathematical models for assessing the fire resistance of fire-retardant reinforced concrete structures have been developed. An algorithm was applied, which includes the following stages: selection of the formalization apparatus, construction of the

external description, verification of the model's operability, construction of the internal state, verification of operability and identification of parameters. The initial and boundary conditions for the construction of these models are formulated, which allow to predict the fire resistance of the fire-resistant reinforced concrete structure with sufficient accuracy for engineering calculations. The peculiarity of the developed models is taking into account the thermophysical characteristics of reinforced concrete structures and fire-retardant coatings, as well as taking into account the peculiarities of the formation of fire regimes.

4. Physical and mathematical models for assessing the fire resistance of fire-retardant steel structures have been developed. An algorithm is used, which includes experimental and computational procedures in determining the fire resistance of fire-resistant steel structures. The initial and boundary conditions for the construction of these models are formulated, which allow to predict the fire resistance of the fire-resistant steel structure with sufficient accuracy for engineering calculations. The peculiarity of the developed models is taking into account the thermophysical characteristics of steel structures and fire-retardant coatings, as well as taking into account the peculiarities of the formation of fire regimes. Based on the proposed physical and mathematical models, a computational and experimental method for estimating the fire resistance of fire-retardant steel structures has been developed. The method is based on the use of samples of reduced size, which facilitates the procedure of determining the normalized values of the limit of fire resistance. The structural-logical scheme of implementation of the developed method provides for 9 blocks located on 5 levels, connected by logical connections, and includes experimental and computational parts. In this case, the experimental part of the method involves the study of the temperature of fire-retardant steel plates under fire conditions for specified fire conditions (standard, external, hydrocarbon, tunnel, real fire) and taking into account influence of climatic factors on the coating. Calculation part – construction of mathematical, physical, geometric, computer models of processes occurring in the studied fire-retardant steel structure, identification of thermophysical characteristics of fire-retardant coating (coefficient of thermal conductivity, specific volumetric heat capacity) by solving inverse problems of thermal conductivity the ability of fire-retardant coating by solving direct problems of thermal conductivity.

5. The reliability of the developed mathematical model and calculation-experimental method for estimating the fire resistance of fire-resistant reinforced concrete structures using the method of computational experiment, which determined the permissible errors. It was found that random errors of 10 % when measuring temperatures from the unheated surface of the fire-retardant floor significantly affect the accuracy of determining the thermophysical characteristics of the coating (maximum error up to 30 %). To analyze the sensitivity of the proposed model, a technique was used, which consists in sequential perturbation of model parameters, identification of thermophysical characteristics of fire-retardant coatings and solving a series of direct problems of thermal conductivity. As a result, it is established that the greatest influence on the accuracy of fire resistance of fire-retardant reinforced concrete structures have such parameters of the mathematical model as the coefficient of thermal conductivity of fire-retardant coating and specific volumetric

heat capacity of reinforced concrete floor. The influence of the heat transfer coefficient between the unheated floor surface and the environment in assessing the fire resistance of fire-retardant multi-hollow reinforced concrete floors on the accuracy of determining the thermophysical characteristics of the fire-retardant coating. The reliability of the developed mathematical model and calculation-experimental method for estimating the fire resistance of fire-retardant steel structures is verified. Accidental errors in measuring temperatures of 10 and 20 % from the unheated surface of a fire-retardant steel structure have been found to significantly affect the accuracy of thermophysical characteristics of the coating to protect steel structures and must be taken into account when designing buildings and structures. Inaccuracy in measuring temperatures from the unheated surface of the fire-retardant steel structure by 10 % leads to an error in determining the thermophysical characteristics of the coating at 17 %, and for 20 % – the error was 34 %.

## REFERENCES

1. Serant, A. Y., Sokha, Yu. I. (2012). Peculiarities and principles of formation of the system of public administration of natural and man-caused safety. *Efficacy public administration*, 32, 457–465.
2. Pospelov, B., Rybka, E., Togobytska, V., Meleshchenko, R., Danchenko, Y., Butenko, T. et. al. (2019). Construction of the method for semi-adaptive threshold scaling transformation when computing recurrent plots. *Eastern-European Journal of Enterprise Technologies*, 4 (10 (100)), 22–29. doi: <http://doi.org/10.15587/1729-4061.2019.176579>
3. Tiutiunyk, V. V., Ivanets, H. V., Tolkunov, I. A., Stetsyuk, E. I. (2018). System approach for readiness assessment units of civil defense to actions at emergency situations. *Scientific Bulletin of National Mining University*, 1, 99–105. doi: <http://doi.org/10.29202/nvngu/2018-1/7>
4. Pospelov, B., Rybka, E., Meleshchenko, R., Gornostal, S., Shcherbak, S. (2017). Results of experimental research into correlations between hazardous factors of ignition of materials in premises. *Eastern-European Journal of Enterprise Technologies*, 6 (10 (90)), 50–56. doi: <http://doi.org/10.15587/1729-4061.2017.117789>
5. Pospelov, B., Rybka, E., Meleshchenko, R., Borodych, P., Gornostal, S. (2019). Development of the method for rapid detection of hazardous atmospheric pollution of cities with the help of recurrence measures. *Eastern-European Journal of Enterprise Technologies*, 1 (10 (97)), 29–35. doi: <http://doi.org/10.15587/1729-4061.2019.155027>
6. Pospelov, B., Andronov, V., Rybka, E., Krainiukov, O., Karpets, K., Pirohov, O. et. al. (2019). Development of the correlation method for operative detection of recurrent states. *Eastern-European Journal of Enterprise Technologies*, 6 (4 (102)), 39–46. doi: <http://doi.org/10.15587/1729-4061.2019.187252>
7. Kustov, M., Kalugin, V., Tutunik, V., Tarakhno, O. (2019). Physicochemical principles of the technology of modified pyrotechnic compositions to reduce the chemical pollution of the atmosphere. *Voprosy Khimii i Khimicheskoi Tekhnologii*, 1, 92–99. doi: <http://doi.org/10.32434/0321-4095-2019-122-1-92-99>
8. Vasyukov, A., Loboichenko, V., Bushtec, S. (2016). Identification of bottled natural waters by using direct conductometry. *Ecology, Environment and Conservation*, 22 (3), 1171–1176.
9. Dadashov, I., Loboichenko, V., Kireev, A. (2018). Analysis of the ecological characteristics of environment friendly fire fighting chemicals used in extinguishing oil products. *Pollution Research Paper*, 37 (1), 63–77.
10. Migalenko, K., Nuianzin, V., Zemlianskyi, A., Dominik, A., Pozdieiev, S. (2018). Development of the technique for restricting the propagation of fire in natural peat ecosystems.

- 
- Eastern-European Journal of Enterprise Technologies, 1 (10 (91)), 31–37. doi: <http://doi.org/10.15587/1729-4061.2018.121727>
11. Popov, O., Iatsyshyn, A., Kovach, V., Artemchuk, V., Taraduda, D., Sobyna, V. et al. (2019). Analysis of Possible Causes of NPP Emergencies to Minimize Risk of Their Occurrence. *Nuclear and Radiation Safety*, 1 (81), 75–80. doi: [http://doi.org/10.32918/nrs.2019.1\(81\).13](http://doi.org/10.32918/nrs.2019.1(81).13)
  12. Vambol, S., Vambol, V., Kondratenko, O., Suchikova, Y., Hurenko, O. (2017). Assessment of improvement of ecological safety of power plants by arranging the system of pollutant neutralization. *Eastern-European Journal of Enterprise Technologies*, 3 (10 (87)), 63–73. doi: <http://doi.org/10.15587/1729-4061.2017.102314>
  13. Pospelov, B., Rybka, E., Meleshchenko, R., Krainiukov, O., Harbuz, S., Bezuhla, Y. et al. (2020). Use of uncertainty function for identification of hazardous states of atmospheric pollution vector. *Eastern-European Journal of Enterprise Technologies*, 2 (10 (104)), 6–12. doi: <http://doi.org/10.15587/1729-4061.2020.200140>
  14. Sadkovi, V., Pospelov, B., Andronov, V., Rybka, E., Krainiukov, O., Rud, A. et al. (2020). Construction of a method for detecting arbitrary hazard pollutants in the atmospheric air based on the structural function of the current pollutant concentrations. *Eastern-European Journal of Enterprise Technologies*, 6 (10 (108)), 14–22. doi: <http://doi.org/10.15587/1729-4061.2020.218714>
  15. Dubinin, D., Korytchenko, K., Lisnyak, A., Hrytsyna, I., Trigub, V. (2017). Numerical simulation of the creation of a fire fighting barrier using an explosion of a combustible charge. *Eastern-European Journal of Enterprise Technologies*, 6 (10 (90)), 11–16. doi: <http://doi.org/10.15587/1729-4061.2017.114504>
  16. Danchenko, Y., Andronov, V., Kariev, A., Lebedev, V., Rybka, E., Meleshchenko, R., Yavorska, D. (2017). Research into surface properties of disperse fillers based on plant raw materials. *Eastern-European Journal of Enterprise Technologies*, 5 (12 (89)), 20–26. doi: <http://doi.org/10.15587/1729-4061.2017.111350>
  17. Danchenko, Y., Andronov, V., Barabash, E., Obigenko, T., Rybka, E., Meleshchenko, R., Romin, A. (2017). Research of the intramolecular interactions and structure in epoxyamine composites with dispersed oxides. *Eastern-European Journal of Enterprise Technologies*, 6 (12 (90)), 4–12. doi: <http://doi.org/10.15587/1729-4061.2017.118565>
  18. Otrosh, Y., Semkiv, O., Rybka, E., Kovalov, A. (2019). About need of calculations for the steel framework building in temperature influences conditions. *IOP Conference Series: Materials Science and Engineering*, 708 (1), 012065. doi: <http://doi.org/10.1088/1757-899x/708/1/012065>
  19. Dubinin, D., Korytchenko, K., Lisnyak, A., Hrytsyna, I., Trigub, V. (2018). Improving the installation for fire extinguishing with finelydispersed water. *Eastern-European Journal of Enterprise Technologies*, 6 (10 (108)), 14–22. doi: <http://doi.org/10.15587/1729-4061.2018.121727>
-



- 
- nal of Enterprise Technologies, 2 (10 (92)), 38–43. doi: <http://doi.org/10.15587/1729-4061.2018.127865>
20. Kondratenko, O., Vambol, S., Stokov, O., Avramenko, A. (2015). Mathematical model of the efficiency of diesel particulate matter filter. *Naukovyi Visnyk Natsionalnoho Hirnychoho Universytetu*, 6, 55–61.
  21. Semko, A., Beskrovnaya, M., Vinogradov, S., Hritsina, I., Yagudina, N. (2014). The usage of high speed impulse liquid jets for putting out gas blowouts. *Journal of Theoretical and Applied Mechanics*, 52 (3), 655–664.
  22. Pospelov, B., Andronov, V., Rybka, E., Meleshchenko, R., Gornostal, S. (2018). Analysis of correlation dimensionality of the state of a gas medium at early ignition of materials. *Eastern-European Journal of Enterprise Technologies*, 5 (10 (95)), 25–30. doi: <http://doi.org/10.15587/1729-4061.2018.142995>
  23. Panchenko, A., Voloshina, A., Boltyansky, O., Milaeva, I., Grechka, I., Khovansky, S. et al. (2018). Designing the flow-through parts of distribution systems for the PRG series planetary hydraulic motors. *Eastern-European Journal of Enterprise Technologies*, 3 (1 (93)), 67–77. doi: <http://doi.org/10.15587/1729-4061.2018.132504>
  24. Pospelov, B., Andronov, V., Rybka, E., Popov, V., Romin, A. (2018). Experimental study of the fluctuations of gas medium parameters as early signs of fire. *Eastern-European Journal of Enterprise Technologies*, 1 (10 (91)), 50–55. doi: <http://doi.org/10.15587/1729-4061.2018.122419>
  25. Vambol, S., Vambol, V., Bogdanov, I., Suchikova, Y., Rashkevich, N. (2017). Research of the influence of decomposition of wastes of polymers with nano inclusions on the atmosphere. *Eastern-European Journal of Enterprise Technologies*, 6 (10 (90)), 57–64. doi: <http://doi.org/10.15587/1729-4061.2017.118213>
  26. Danchenko, Y., Andronov, V., Teslenko, M., Permiakov, V., Rybka, E., Meleshchenko, R., Kosse, A. (2018). Study of the free surface energy of epoxy composites using an automated measurement system. *Eastern-European Journal of Enterprise Technologies*, 1 (12 (91)), 9–17. doi: <http://doi.org/10.15587/1729-4061.2018.120998>
  27. Otrosh, Y., Rybka, Y., Danilin, O., Zhuravskiy, M. (2019). Assessment of the technical state and the possibility of its control for the further safe operation of building structures of mining facilities. *E3S Web of Conferences*, 123, 01012. doi: <http://doi.org/10.1051/e3sconf/201912301012>
  28. Andronov, V., Pospelov, B., Rybka, E., Skliarov, S. (2017). Examining the learning fire detectors under real conditions of application. *Eastern-European Journal of Enterprise Technologies*, 3 (9 (87)), 53–59. doi: <http://doi.org/10.15587/1729-4061.2017.101985>
  29. Pospelov, B., Andronov, V., Rybka, E., Popov, V., Semkiv, O. (2018). Development of the method of frequencytemporal representation of fluctuations of gaseous medium param-
-

- ters at fire. *Eastern-European Journal of Enterprise Technologies*, 2 (10 (92)), 44–49. doi: <http://doi.org/10.15587/1729-4061.2018.125926>
30. Pospelov, B., Andronov, V., Rybka, E., Meleshchenko, R., Borodych, P. (2018). Studying the recurrent diagrams of carbon monoxide concentration at early ignitions in premises. *Eastern-European Journal of Enterprise Technologies*, 3 (9 (93)), 34–40. doi: <http://doi.org/10.15587/1729-4061.2018.133127>
31. Andronov, V., Pospelov, B., Rybka, E. (2017). Development of a method to improve the performance speed of maximal fire detectors. *Eastern-European Journal of Enterprise Technologies*, 2 (9 (86)), 32–37. doi: <http://doi.org/10.15587/1729-4061.2017.96694>
32. Pospelov, B., Andronov, V., Rybka, E., Skliarov, S. (2017). Research into dynamics of setting the threshold and a probability of ignition detection by selfadjusting fire detectors. *Eastern-European Journal of Enterprise Technologies*, 5 (9 (89)), 43–48. doi: <http://doi.org/10.15587/1729-4061.2017.110092>
33. Osipchik, V. S., Yakovleva, R. A., Spirina, E. Y., Obizhenko, T. N., Rybko, E. A., Kondratenko, A. V. (2011). Influence of the Composition of the Redox System on the Thermo-Oxidative Degradation of Intercalated Graphites. *International Polymer Science and Technology*, 38 (1), 53–56. doi: <http://doi.org/10.1177/0307174x1103800111>
34. Pospelov, B., Andronov, V., Rybka, E., Skliarov, S. (2017). Design of fire detectors capable of self-adjusting by ignition. *Eastern-European Journal of Enterprise Technologies*, 4 (9 (88)), 53–59. doi: <http://doi.org/10.15587/1729-4061.2017.108448>
35. Abramov, Yu. A., Rybka, E. A., Gvozd, V. M. (2013). Termicheskie kompleks dlya ispytaniy obraztsov stroitelnykh konstruksii. Kharkiv: NUGZU, 128.
36. Pro zatverdzhennia Tekhnichnoho rehlamentu budivelnnykh vyrobiv, budivel i sporud (2006). Postanova KМУ No. 1764. 20.12.2006. Available at: <https://zakon.rada.gov.ua/laws/show/1764-2006-%D0%BF#Text>
37. Ragimov, S., Sobyna, V., Vambol, S., Vambol, V., Feshchenko, A., Zakora, A. et. al. (2018). Physical modelling of changes in the energy impact on a worker taking into account high-temperature radiation. *Journal of Achievements in Materials and Manufacturing Engineering*, 1 (91), 27–33. doi: <http://doi.org/10.5604/01.3001.0012.9654>
38. Kustov, M., Slepuzhnikov, E., Lipovoy, V., Khmyrov, I., Dadashov, I. F., Buskin, O. (2019). Procedure for Implementation of the Method of Artificial Deposition of Radioactive Substances from the Atmosphere. *Nuclear and Radiation Safety*, 3 (83), 13–25. doi: [http://doi.org/10.32918/nrs.2019.3\(83\).02](http://doi.org/10.32918/nrs.2019.3(83).02)
39. Dubinin, D., Cherkashyn, O., Maksymov, A., Beliuchenko, D., Hovalenkov, S., Shevchenko, S., Avetisyan, V. (2020). Investigation of the effect of carbon monoxide on people in case of fire in a building. *Sigurnost*, 62 (4), 347–357. doi: <http://doi.org/10.31306/s.62.4.2>
40. Otrosh, Y., Kovalov, A., Semkiv, O., Rudeshko, I., Diven, V. (2018). Methodology remaining lifetime determination of the building structures. *MATEC Web of Conferences*, 230, 02023. doi: <http://doi.org/10.1051/mateconf/201823002023>

- 
41. Otrosh, Y., Surianinov, M., Golodnov, A., Starova, O. (2019). Experimental and Computer Researches of Ferroconcrete Beams at High-Temperature Influences. *Materials Science Forum*, 968, 355–360. doi: <http://doi.org/10.4028/www.scientific.net/msf.968.355>
  42. Vasiliev, M. I., Movchan, I. O., Koval, O. M. (2014). Diminishing of ecological risk via optimization of fire-extinguishing system projects in timber-yards. *Naukovyi Visnyk Natsionalnoho Hirnychoho Universytetu*, 5, 106–113.
  43. Popov, O., Iatsyshyn, A., Kovach, V., Artemchuk, V., Kameneva, I., Taraduda, D. et. al. (2020). Risk Assessment for the Population of Kyiv, Ukraine as a Result of Atmospheric Air Pollution. *Journal of Health and Pollution*, 10 (25). doi: <http://doi.org/10.5696/2156-9614-10.25.200303>
  44. Popov, O., Iatsyshyn, A., Kovach, V., Artemchuk, V., Taraduda, D., Sobyna, V. et. al. (2019). Physical Features of Pollutants Spread in the Air During the Emergency at NPPs. *Nuclear and Radiation Safety*, 4 (84), 88–98. doi: [http://doi.org/10.32918/nrs.2019.4\(84\).11](http://doi.org/10.32918/nrs.2019.4(84).11)
  45. Novak, S. V., Nefedchenko, L. M., Abramov, O. O. (2010). *Metody vyprobuvan budivelnnykh konstrukttsii ta vyrobiv na vohnestiiikist*. Kyiv: Pozhinformtekhnik, 132.
  46. Bashynska, O., Otrosh, Y., Holodnov, O., Tomashevskiy, A., Venzhego, G. (2020). Methodology for Calculating the Technical State of a Reinforced-Concrete Fragment in a Building Influenced by High Temperature. *Materials Science Forum*, 1006, 166–172. doi: <http://doi.org/10.4028/www.scientific.net/msf.1006.166>
  47. Kovalov, A., Otrosh, Y., Rybka, E., Kovalevska, T., Togobytska, V., Rolin, I. (2020). Treatment of Determination Method for Strength Characteristics of Reinforcing Steel by Using Thread Cutting Method after Temperature Influence. *Materials Science Forum*, 1006, 179–184. doi: <http://doi.org/10.4028/www.scientific.net/msf.1006.179>
  48. Pozdieiev, S., Nuianzin, O., Sidnei, S., Shchipets, S. (2017). Computational study of bearing walls fire resistance tests efficiency using different combustion furnaces configurations. *MATEC Web of Conferences*, 116, 02027. doi: <http://doi.org/10.1051/mateconf/201711602027>
  49. Nuianzin, O., Pozdieiev, S., Hora, V., Shvydenko, A., Samchenko, T. (2018). Experimental study of temperature mode of a fire in a cable tunnel. *Eastern-European Journal of Enterprise Technologies*, 3 (10 (93)), 21–27. doi: <http://doi.org/10.15587/1729-4061.2018.131792>
  50. Otrosh, Yu. A., Poklonskyi, V. H., Fesenko, O. A., Tarasiuk, V. H., Nemchynov, Yu. I., Baitala, Kh. Z. et. al. (2016). *Rozrakhunok zalizobetonnykh konstrukttsii na vohnestiiikist vidpovidno do Yevrokodu 2*. Kyiv: Intertekhnolohiia, 83.
  51. Gravit, M., Golub, E. (2018). The fire resistant ceiling construction in a hydrocarbon fire. *MATEC Web of Conferences*, 245, 03004. doi: <http://doi.org/10.1051/mateconf/201824503004>
-

- 
52. Vasilchenko, A., Doronin, E., Chernenko, O., Ponomarenko, I. (2019). Estimation of fire resistance of bending reinforced concrete elements based on concrete with disperse fibers. *IOP Conference Series: Materials Science and Engineering*, 708 (1), 012075. doi: <http://doi.org/10.1088/1757-899x/708/1/012075>
  53. Surianinov, M., Andronov, V., Otrosh, Y., Makovkina, T., Vasiukov, S. (2020). Concrete and Fiber Concrete Impact Strength. *Materials Science Forum*, 1006, 101–106. doi: <http://doi.org/10.4028/www.scientific.net/msf.1006.101>
  54. Nekora, O., Slovynsky, V., Pozdieiev, S. (2017). The research of bearing capacity of reinforced concrete beam with use combined experimental-computational method. *MATEC Web of Conferences*, 116, 02024. doi: <http://doi.org/10.1051/mateconf/201711602024>
  55. Pozdieiev, S., Nekora, O., Kryshal, T., Zazhoma, V., Sidnei, S. (2018). Method of the calculated estimation of the possibility of progressive destruction of buildings in result of fire. *MATEC Web of Conferences*, 230, 02026. doi: <http://doi.org/10.1051/mateconf/201823002026>
  56. Jiangtao, Y., Yichao, W., Kexu, H., Kequan, Y., Jianzhuang, X. (2017). The performance of near-surface mounted CFRP strengthened RC beam in fire. *Fire Safety Journal*, 90, 86–94. doi: <http://doi.org/10.1016/j.firesaf.2017.04.031>
  57. Roitman, V. M., Gabdulin, R. Sh. (2013). Obespechenie stoikosti zhelezobetonnykh konstruksii protiv vzryvoobraznogo razrusheniya pri pozhare s pomoshchyu tonkosloynnykh ognemaschitnykh vspuchivayuschikhsya pokrytii. *Pozhary i chrezvychainye situatsii: predotvraschenie, likvidatsiya*, 2-13, 11–16.
  58. Takla, M., Tarsha, I. (2020). Effect of temperature on carrying capacity of concrete columns confined with multi-layers of CFRP. *Jordan Journal of Civil Engineering*, 14 (1), 14–26.
  59. Vasilchenko, A., Doronin, E., Ivanov, B., Konoval, V. (2019). Effect of Residual Deformation of a Steel Column on its Fire Resistance under Combined Exposure “Explosion-Fire.” *Materials Science Forum*, 968, 288–293. doi: <http://doi.org/10.4028/www.scientific.net/msf.968.288>
  60. Korytcheko, K. V., Ozerov, A. N., Vinnikov, D. V., Skob, Y. A., Dubinin, D. P., Meleshchenko, R. G. (2018). Numerical simulation of influence of the non-equilibrium excitation of molecules on direct detonation initiation by spark discharge. *Problems of Atomic Science and Technology*, 116 (4), 194–199.
  61. Skob, Y., Ugryumov, M., Dreval, Y. (2020). Numerical Modelling of Gas Explosion Overpressure Mitigation Effects. *Materials Science Forum*, 1006, 117–122. doi: <http://doi.org/10.4028/www.scientific.net/msf.1006.117>
  62. Xue, C. (2020). Research on steel structure technology in civil engineering construction. *IOP Conference Series: Earth and Environmental Science*, 474 (7), 072072. doi: <http://doi.org/10.1088/1755-1315/474/7/072072>
  63. Zhong, B., Zhang, Z., Ge, X., He, S., Huang, H. (2020). Development and Application of Fire-proof Coatings for Fabricated Steel Structures. *Material Sciences*, 10 (12), 1027–1033. doi: <http://doi.org/10.12677/ms.2020.1012121>
-

- 
64. Zhu, Y. Y., Zhao, D. L., He, Q., Zhang, J. X., Li, L. Y., Ma, D. D. (2014). Preparation and property of MCMB fireproof coating for steel structure. *Gongneng Cailiao/Journal of Functional Materials*, 45 (3), 03145–03148. doi: <http://doi.org/10.3969/j.issn.1001-9731.2014.03.032>
  65. Xu, Q., Li, G.-Q., Wang, Y. C., Bisby, L. (2020). An experimental study of the behavior of intumescent coatings under localized fires. *Fire Safety Journal*, 115, 103003. doi: <http://doi.org/10.1016/j.firesaf.2020.103003>
  66. De Silva, D., Bilotta, A., Nigro, E. (2020). Approach for modelling thermal properties of intumescent coating applied on steel members. *Fire Safety Journal*, 116. doi: <http://doi.org/10.1016/j.firesaf.2020.103200>
  67. Morys, M., Häbler, D., Krüger, S., Schartel, B., Hothan, S. (2020). Beyond the standard time-temperature curve: Assessment of intumescent coatings under standard and deviant temperature curves. *Fire Safety Journal*, 112, 102951. doi: <http://doi.org/10.1016/j.firesaf.2020.102951>
  68. Bychkov, A. S., Kondratiev, A. V. (2019). Criterion-Based Assessment of Performance Improvement for Aircraft Structural Parts with Thermal Spray Coatings. *Journal of Superhard Materials*, 41 (1), 53–59. doi: <http://doi.org/10.3103/s1063457619010088>
  69. Wang, L., Chen, B., Zhang, C., Li, G. (2019). Experimental study on insulative properties of intumescent coating exposed to standard and nonstandard furnace curves. *Fire and Materials*, 43 (7), 782–793. doi: <http://doi.org/10.1002/fam.2737>
  70. Maciulaitis, R., Grigonis, M., Malaiskiene, J. (2018). The impact of the aging of intumescent fire protective coatings on fire resistance. *Fire Safety Journal*, 98, 15–23. doi: <http://doi.org/10.1016/j.firesaf.2018.03.007>
  71. Tian, N., Delichatsios, M. A., Zhang, J., Fateh, T. (2018). A methodology and a simple engineering fire performance model for Intumescent Fire Retardant coatings. *Fire Safety Journal*, 98, 120–129. doi: <http://doi.org/10.1016/j.firesaf.2018.04.010>
  72. Pozdieiev, S., Nuianzin, O., Borsuk, O., Nedilko, I. (2021). Research of Integrity of Fire Insulation Cladding with Mineral Wool of Steel Beam under Fire Impact. *IOP Conference Series: Materials Science and Engineering*, 1021 (1), 012024. doi: <http://doi.org/10.1088/1757-899x/1021/1/012024>
  73. Dreyer, J. A. H., Weinell, C. E., Dam-Johansen, K., Kiil, S. (2021). Review of heat exposure equipment and in-situ characterisation techniques for intumescent coatings. *Fire Safety Journal*, 121, 103264. doi: <http://doi.org/10.1016/j.firesaf.2020.103264>
  74. Lucherini, A., Giuliani, L., Jomaas, G. (2018). Experimental study of the performance of intumescent coatings exposed to standard and non-standard fire conditions. *Fire Safety Journal*, 95, 42–50. doi: <http://doi.org/10.1016/j.firesaf.2017.10.004>
  75. Roitman, V. M. (2006). Inzhenernye aspekty sobytiy 11 sentyabrya 2001 goda v Nyu-lorke pri atake terroristami bashen Vsemirnogo trgovogo tsentra. *Globalnaya bezopasnost*, 3, 30–35.
-

- 
76. De Souza, R. C. S., Andreini, M., La Mendola, S., Zehfuß, J., Knaust, C. (2019). Probabilistic thermo-mechanical finite element analysis for the fire resistance of reinforced concrete structures. *Fire Safety Journal*, 104, 22–33. doi: <http://doi.org/10.1016/j.firesaf.2018.12.005>
  77. Rastorguev, B. S., Plotnikov, A., Khusnutdinov, D. Z. (2007). Proektirovanie zdaniy i sooruzheniy pri aviariynkh vzryvnykh vozdeystviyakh. Izdatelstvo Assotsiatsii stroitelnykh vuzov, 154.
  78. Pershakov, V. M., Barabash, M. S., Bieliatynskiy, A. O., Lysnytska, K. M. (2015). Problemy protydyi konstruksii prohresuiuchomu obvalenniu budivel ta sporud. Kyiv, 456.
  79. Manco Rivera, M. R., Vaz, M. A., Cyrino, J. C. R., Landesmann, A. (2021). A study on the use of fireproof protection in offshore topside steel structures subject to localised fires. *Marine Systems & Ocean Technology*, 16 (2), 55–68. doi: <http://doi.org/10.1007/s40868-021-00102-x>
  80. Bolina, F. L., Prager, G. L., Rodrigues, E., Tutikian, B. F. (2015). Evaluation of fire resistance of massive reinforced concrete walls. *Ambiente Construído*, 15 (4), 291–305. doi: <http://doi.org/10.1590/s1678-86212015000400051>
  81. Lucherini, A., Maluk, C. (2019). Assessing the onset of swelling for thin intumescent coatings under a range of heating conditions. *Fire Safety Journal*, 106, 1–12. doi: <http://doi.org/10.1016/j.firesaf.2019.03.014>
  82. Zeng, Y., Weinell, C. E., Dam-Johansen, K., Ring, L., Kiil, S. (2020). Comparison of an industrial- and a laboratory-scale furnace for analysis of hydrocarbon intumescent coating performance. *Journal of Fire Sciences*, 38 (3), 309–329. doi: <http://doi.org/10.1177/0734904120902852>
  83. Mariappan, T. (2016). Recent developments of intumescent fire protection coatings for structural steel: A review. *Journal of Fire Sciences*, 34 (2), 120–163. doi: <http://doi.org/10.1177/0734904115626720>
  84. Zavyalov, D. E. (2013). Povyshenie effektivnosti ognezaschitnykh vspuchivayuschikhsya kompozitsii. Saint Petersburg, 118.
  85. Cirpici, B. K., Wang, Y. C., Rogers, B. (2016). Assessment of the thermal conductivity of intumescent coatings in fire. *Fire Safety Journal*, 81, 74–84. doi: <http://doi.org/10.1016/j.firesaf.2016.01.011>
  86. Gillet, M., Perez, L., Autrique, L. (2019). A model based predictive tool for fire safety intumescent coatings design. *Fire Safety Journal*, 110, 102908. doi: <http://doi.org/10.1016/j.firesaf.2019.102908>
  87. Novak, S. V., Drizhd, V. L., Dobrostan, O. V. (2018). Analysis of modern european methods of evaluation of fireproof ability of fireproof materials for building constructions. *Naukovyi visnyk: tsyvilnyi zakhyst ta pozhezhdna bezpeka*, 5 (1), 74–85.
  88. Michel, M. A., Tutikian, B. F., Ortolan, V., Oliveira, M. L. S., Sampaio, C. H., Gómez P, L., Silva, L. F. O. (2019). Fire resistance performance of concrete-PVC panels with polyvinyl chloride (PVC) stay in place (SIP) formwork. *Journal of Materials Research and Technology*, 8 (5), 4094–4107. doi: <http://doi.org/10.1016/j.jmrt.2019.07.018>
-

- 
89. Michel Murillo, A., Valery Abisambra, G., Aura Acosta, P., Claudia Guesada, Q., Tutikian, B. F., Ehrenbring, H. Z. (2021). Comparison of the fire resistance behaviour of structural insulated panels with expanded polystyrene core treated with intumescent coating. *Journal of Materials Research and Technology*, 12, 1958–1969. doi: <http://doi.org/10.1016/j.jmrt.2021.03.079>
  90. Zhang, T., Zhang, Y., Xiao, Z., Yang, Z., Zhu, H., Ju, J. W., Yan, Z. (2019). Development of a novel bio-inspired cement-based composite material to improve the fire resistance of engineering structures. *Construction and Building Materials*, 225, 99–111. doi: <http://doi.org/10.1016/j.conbuildmat.2019.07.121>
  91. Beh, J. H., Yew, M. C., Saw, L. H. (2020). Development of lightweight fire resistant sandwich panel. *IOP Conference Series: Earth and Environmental Science*, 476 (1), 012031. doi: <http://doi.org/10.1088/1755-1315/476/1/012031>
  92. Shepel, S. V., Wakili, K. G., Hugi, E. (2012). Investigation of heat transfer in gypsum plasterboard exposed to fire for three nominal fire scenarios. *Journal of Fire Sciences*, 30 (3), 240–255. doi: <http://doi.org/10.1177/0734904111433265>
  93. Medri, V., Papa, E., Mazzocchi, M., Laghi, L., Morganti, M., Francisconi, J., Landi, E. (2015). Production and characterization of lightweight vermiculite/geopolymer-based panels. *Materials & Design*, 85, 266–274. doi: <http://doi.org/10.1016/j.matdes.2015.06.145>
  94. Gulida, E. M., Renkas, A. A. (2012). The fire-resistant of concreteslabs in residential and administrative buildings. *Problemy požarnoi bezopasnosti*, 32, 62–73.
  95. Strakhov, V. L., Krutov, A. M., Davydkin, N. F. (2000). *Ognezaschita stroitelnykh konstrukt-sii*. Moscow: TIMR, 433.
  96. Chernukha, A., Teslenko, A., Kovalov, P., Bezuglov, O. (2020). Mathematical Modeling of Fire-Proof Efficiency of Coatings Based on Silicate Composition. *Materials Science Forum*, 1006, 70–75. doi: <http://doi.org/10.4028/www.scientific.net/msf.1006.70>
  97. Skorodumova, O., Tarakhno, O., Chebotaryova, O., Hapon, Y., Emen, F. M. (2020). Formation of Fire Retardant Properties in Elastic Silica Coatings for Textile Materials. *Materials Science Forum*, 1006, 25–31. doi: <http://doi.org/10.4028/www.scientific.net/msf.1006.25>
  98. Kireev, A., Tregubov, D., Safronov, S., Saveliev, D. (2020). Study Insulating and Cooling Properties of the Material on the Basis of Crushed Foam Glass and Determination of its Extinguishing Characteristics with the Attitude to Alcohols. *Materials Science Forum*, 1006, 62–69. doi: <http://doi.org/10.4028/www.scientific.net/msf.1006.62>
  99. Puri, R. G., Khanna, A. S. (2016). Intumescent coatings: A review on recent progress. *Journal of Coatings Technology and Research*, 14 (1), 1–20. doi: <http://doi.org/10.1007/s11998-016-9815-3>
  100. Xu, Q., Li, G.-Q., Jiang, J., Wang, Y. C. (2018). Experimental study of the influence of topcoat on insulation performance of intumescent coatings for steel structures. *Fire Safety Journal*, 101, 25–38. doi: <http://doi.org/10.1016/j.firesaf.2018.08.006>
-

- 
101. Li, G.-Q., Han, J., Lou, G.-B., Wang, Y. C. (2016). Predicting intumescent coating protected steel temperature in fire using constant thermal conductivity. *Thin-Walled Structures*, 98, 177–184. doi: <http://doi.org/10.1016/j.tws.2015.03.008>
  102. Tsoi, A. A., Demekhin, F. V. (2016). Criteria of model of fire rating of flame-retardant coating for steel structures in the conditions of hydrocarbon jet fire. *Mezhdunarodnyi nauchno-issledovatel'skii zhurnal*, 6–2 (48), 161–165.
  103. Holodnov, O. I., Antoshyna, T. V., Otrosh, Yu. A. (2017). About necessity of calculation of buildings with steel framework on thermal actions. *Zbirnyk naukovykh prats Ukrain'skoho instytutu stalevykh konstruksii imeni V. M. Shymanovskoho*, 20, 65–84.
  104. Gravit, M., Gumerova, E., Bardin, A., Lukinov, V. (2017). Increase of fire resistance limits of building structures of oil-and-gas complex under hydrocarbon fire. *Energy Management of Municipal Transportation Facilities and Transport*. Cham: Springer, 818–829. doi: [http://doi.org/10.1007/978-3-319-70987-1\\_87](http://doi.org/10.1007/978-3-319-70987-1_87)
  105. Imran, M., Liew, M. S., Nasif, M. S., Niazi, U. M., Yasreen, A. (2017). Hazard Assessment Studies on Hydrocarbon Fire and Blast: An Overview. *Advanced Science Letters*, 23 (2), 1243–1247. doi: <http://doi.org/10.1166/asl.2017.8349>
  106. Abramov, I. V., Gravit, M. V., Gumerova, E. I. (2018). Increase in the fire resistance limits of ship and building structures with hydrocarbon fire. *Gazovaya promyshlennost*, 5 (768), 106–115.
  107. Lucherini, A., Maluk, C. (2019). Intumescent coatings used for the fire-safe design of steel structures: A review. *Journal of Constructional Steel Research*, 162, 105712. doi: <http://doi.org/10.1016/j.jcsr.2019.105712>
  108. Sobur, S. V. (2008). *Ognezaschita materialov i konstruksii*. Moscow: Izdatel'stvo "PozhKniga", 216.
  109. Wang, L., Wang, Y., Zeng, W. (2021). An experimental study on crack and debonding of intumescent coatings and their effects on temperature development of steel elements. *Fire Safety Journal*, 122, 103325. doi: <http://doi.org/10.1016/j.firesaf.2021.103325>
  110. Yew, M. C., Ramli Sulong, N. H. (2012). Fire-resistive performance of intumescent flame-retardant coatings for steel. *Materials & Design*, 34, 719–724. doi: <http://doi.org/10.1016/j.matdes.2011.05.032>
  111. Wang, L. L., Wang, Y. C., Li, G. Q., Zhang, Q. Q. (2020). An experimental study of the effects of topcoat on aging and fire protection properties of intumescent coatings for steel elements. *Fire Safety Journal*, 111, 102931. doi: <http://doi.org/10.1016/j.firesaf.2019.102931>
  112. Fateh, T., Guillaume, E., Joseph, P. (2017). An experimental study of the thermal performance of a novel intumescent fire protection coating. *Fire Safety Journal*, 92, 132–141. doi: <http://doi.org/10.1016/j.firesaf.2017.05.021>
  113. Yamschikova, S. A. (2009). Povyshenie ognegaschitnoi sposobnosti vspuchivayuschikhsya pokrytii dlya obektov neftegazovoi otrasli. Ufa, 171.
-



- 
114. Vakhitova, L., Taran, N., Bessarabov, V., Drizhd, V., Pridatko, S., Prudchenko, A. (2018). Development of fire retardant coating for the conditions of hydrocarbon fire with improved rheological characteristics. *Journal of Donetsk Mining Institute*, 1 (42), 103–115. doi: <http://doi.org/10.31474/1999-981x-2018-1-103-115>
  115. Beh, J. H., Yew, M. C., Yew, M. K., Saw, L. H. (2019). Fire Protection Performance and Thermal Behavior of Thin Film Intumescent Coating. *Coatings*, 9 (8), 483. doi: <http://doi.org/10.3390/coatings9080483>
  116. Wang, Y., Zhao, J. (2019). Facile preparation of slag or fly ash geopolymer composite coatings with flame resistance. *Construction and Building Materials*, 203, 655–661. doi: <http://doi.org/10.1016/j.conbuildmat.2019.01.097>
  117. M. Beraldo, C. H., da S. Silveira, M. R., F. Baldissera, A., Ferreira, C. A. (2019). A new benzoxazine-based intumescent coating for passive protection against fire. *Progress in Organic Coatings*, 137, 105321. doi: <http://doi.org/10.1016/j.porgcoat.2019.105321>
  118. Inerhunwa, I., Wang, Y. C., Su, M. (2019). Reliability analysis of intumescent coating protected steel members under the standard fire condition. *Fire Safety Journal*, 104, 43–56. doi: <http://doi.org/10.1016/j.firesaf.2018.12.003>
  119. Pignatta e Silva, V. (2005). Determination of the steel fire protection material thickness by an analytical process – a simple derivation. *Engineering Structures*, 27 (14), 2036–2043. doi: <http://doi.org/10.1016/j.engstruct.2005.05.018>
  120. ENV 13381-4: 2002 Test methods for determining the contribution to the fire resistance of structural members – Part 4: Applied protection to steel members (2002). Available at: <https://standards.iteh.ai/catalog/standards/cen/54633070-6755-4b78-8818-bb6d-3fa92eb7/env-13381-4-2002>
  121. Alcaíno, P., Santa-María, H., Magna-Verdugo, C., López, L. (2020). Experimental fast-assessment of post-fire residual strength of reinforced concrete frame buildings based on non-destructive tests. *Construction and Building Materials*, 234, 117371. doi: <http://doi.org/10.1016/j.conbuildmat.2019.117371>
  122. Nair, A., Salem, O. (Sam). (2020). Experimental determination of the residual compressive strength of concrete columns subjected to different fire durations and load ratios. *Journal of Structural Fire Engineering*, 11 (4), 529–543. doi: <http://doi.org/10.1108/jsfe-10-2019-0034>
  123. Kuehnen, R., Youssef, M., El-Fitiyan, S. (2020). Performance-based design of RC beams using an equivalent standard fire. *Journal of Structural Fire Engineering*, 12 (1), 98–109. doi: <http://doi.org/10.1108/jsfe-02-2020-0008>
  124. Bai, L. L., Song, T. (2012). Failure Analysis of Reinforced Concrete Columns after High Temperature. *Applied Mechanics and Materials*, 157-158, 1578–1581. doi: <http://doi.org/10.4028/www.scientific.net/amm.157-158.1578>
  125. Novak, S., Drizhd, V., Dobrostan, O., Maladyka, L. (2019). Influence of testing samples' parameters on the results of evaluating the fireprotective capability of materials.
-

- Eastern-European Journal of Enterprise Technologies, 2 (10 (98)), 35–42. doi: <http://doi.org/10.15587/1729-4061.2019.164743>
126. De Silva, D., Bilotta, A., Nigro, E. (2019). Experimental investigation on steel elements protected with intumescent coating. *Construction and Building Materials*, 205, 232–244. doi: <http://doi.org/10.1016/j.conbuildmat.2019.01.223>
  127. Nadjai, A., Petrou, K., Han, S., Ali, F. (2016). Performance of unprotected and protected cellular beams in fire conditions. *Construction and Building Materials*, 105, 579–588. doi: <http://doi.org/10.1016/j.conbuildmat.2015.12.150>
  128. Novak, S. V. (2016). Parameters reasoning of samples for experimental determination of the temperature of the steel plates that are fire-retardant coating in conditions of fire exposure under standard temperature fire regime. *Naukovyi visnyk: Tsyvilnyi zakhyst ta pozhezhna bezpeka*, 2, 18–24.
  129. Novak, S. V., Krukovskiy, P. H., Perepylytsia, M. S. (2016). Determination of the temperature distribution in steel construction in terms of fire exposure calculation methods. *Naukovyi visnyk: tsyvilnyi zakhyst ta pozhezhna bezpeka*, 1, 9–15.
  130. Lakhani, H., Kamath, P., Bhargava, P., Sharma, U., Reddy, G. (2013). Thermal Analysis of Reinforced Concrete Structural Elements. *Journal of Structural Fire Engineering*, 4 (4), 227–244. doi: <http://doi.org/10.1260/2040-2317.4.4.227>
  131. Garlińska, U., Michalak, P., Popielarczyk, T. (2015). Szacowanie możliwości utraty nośności konstrukcji budowlanej w warunkach pożaru. *Bezpieczeństwo i Technika Pożarnicza*, 39 (3), 59–66. doi: <http://doi.org/10.12845/bitp.39.3.2015.5>
  132. Biskupska, N., Szymkuć, W. (2016). Towards the simplified modelling of thermal and mechanical response of steel tubular columns exposed to localized fire. *Modern Building Materials, Structures and Techniques*.
  133. Zárate, L. G., Lara, H. E., Cordero, M. E., Kozanoglu, B. (2014). Infrared thermography and CFD analysis of hydrocarbon jet fires. *Chemical Engineering Transactions*, 39, 1357–1362. doi: <http://doi.org/10.3303/CET1439227>
  134. Golodnov, A. I., Kudryashov, V. A., Polevoda, I. I., Otrosh, Yu. A., Tkachuk, I. A., Seminog, N. N., Drobysh, A. S. (2015). Sopotavitel'naya otsenka ognestoikosti zhelezobetonnykh mnogopuslotnykh plit s ispolzovaniem standartov Belarusi, Ukrainy, Evropeiskogo Soyuzha, a takzhe raschetnykh metodov. *Vestnik Universiteta grazhdanskoi zaschity MCHS Belarusi*, 1 (21), 30–39.
  135. Džolev, I., Cvetkovska, M., Radonjanin, V., Lađinović, Đ., Laban, M. (2018). Modelling approach of structural fire performance. *Book of proceedings*, 17–24.
  136. Pozdieiev, S. V., Otrosh, Yu. A., Demeshok, V. V., Fedchenko, I. V. (2016). Rozrakhunkovyi metod otsinky vohnestiikosti plyty perekryttia. *Promyslove budivnytstvo ta inzhenerni sporudy*, 2, 28–33.
  137. Pozdieiev, S. V., Otrosh, Yu. A., Omelchenko, A. M., Kropyva, M. O. (2015). Temperature fields interpretation method in the cross section of reinforced concrete beams. *Zbirnyk naukovykh prats Poltavskoho natsionalnoho tekhnichnoho universytetu im. Yu. Kondratiuka. Seria: Haluzeve mashynobuduvannia, budivnytstvo*, 2, 70–78.

- 
138. Pozdeev, S. V. (2011). Verification of results of the specified calculation method of determination of limits of fire-resistance of reinforced concrete constructions. *Problemy požarnoi bezopasnosti*, 29, 141–148.
  139. Alos-Moya, J., Paya-Zaforteza, I., Garlock, M. E. M., Loma-Ossorio, E., Schiffner, D., Hospitaller, A. (2014). Analysis of a bridge failure due to fire using computational fluid dynamics and finite element models. *Engineering Structures*, 68, 96–110. doi: <http://doi.org/10.1016/j.engstruct.2014.02.022>
  140. Džolev, I., Radujković, A., Cvetkovska, M., Lađinović, Đ., Radonjanin, V. (2016). Fire analysis of a simply supported steel beam using Opensees and Ansys Workbench. 4th International Conference Contemporary Achievements in Civil Engineering. Subotica, 315–322. doi: <http://doi.org/10.14415/konferencijagfs2016.031>
  141. Łukomski, M., Turkowski, P., Roszkowski, P., Papis, B. (2017). Fire Resistance of Unprotected Steel Beams – Comparison between Fire Tests and Calculation Models. *Procedia Engineering*, 172, 665–672. doi: <http://doi.org/10.1016/j.proeng.2017.02.078>
  142. Lin, S., Huang, Z., Fan, M. (2015). The effects of protected beams and their connections on the fire resistance of composite buildings. *Fire Safety Journal*, 78, 31–43. doi: <http://doi.org/10.1016/j.firesaf.2015.08.003>
  143. Lazarevska, M., Cvetkovska, M., Knežević, M., Trombeva Gavriloska, A., Milanovic, M., Murgul, V., Vatin, N. (2014). Neural Network Prognostic Model for Predicting the Fire Resistance of Eccentrically Loaded RC Columns. *Applied Mechanics and Materials*, 627, 276–282. doi: <http://doi.org/10.4028/www.scientific.net/amm.627.276>
  144. Zhang, X., Xiao, Y., Kunnath, S. K. (2015). State of the art and prospect of research on fire resistance behavior of reinforced concrete columns. *Journal of Natural Disasters*, 24 (3), 120–131. doi: <http://doi.org/10.13577/j.jnd.2015.0316>
  145. EN 1992-1-2:2004 Eurocode 2: Design of concrete structures – Part 1-2: General rules – Structural fire design (2004). Available at: <https://www.phd.eng.br/wp-content/uploads/2015/12/en.1992.1.2.2004.pdf>
  146. EN 1363-2: 1999 Fire resistance tests – Part 2: Alternative and additional procedures (1999). Availablr at: <https://standards.iteh.ai/catalog/standards/cen/2c26aa21-abe7-4d96-96a2-eb8fbb4919e0/en-1363-2-1999>
  147. Ng, Y. H., Zope, I. S., Dasari, A., Tan, K. H. (2020). Correlating the Performance of a Fire-Retardant Coating across Different Scales of Testing. *Polymers*, 12 (10), 2271. doi: <http://doi.org/10.3390/polym12102271>
  148. Paik, J. K., Czujko, J. (2012). Engineering and design disciplines associated with management of hydrocarbon explosion and fire risks in offshore oil and gas Facilities. doi: <http://doi.org/10.5957/smc-2012-a24>
  149. Paik, J. K., Czujko, J. (2011). Assessment of hydrocarbon explosion and fire risks in offshore installations: recent advances and future trends. *The IES Journal Part A: Civil & Structural Engineering*, 4 (3), 167–179. doi: <http://doi.org/10.1080/19373260.2011.593345>
-

- 
150. Paik, J. K., Kim, B. J., Jeong, J. S., Kim, S. H., Jang, Y. S., Kim, G. S. et. al. (2010). CFD simulations of gas explosion and fire actions. *Ships and Offshore Structures*, 5 (1), 3–12. doi: <http://doi.org/10.1080/17445300902872028>
  151. Uribe, S., Zárate, L., Suo-Anttila, A., Cordero, M. E., Smith, J. D. (2020). Improvement in the prediction of gasoline pool fire behaviour: CFD modelling and validation. *Journal of Loss Prevention in the Process Industries*, 68, 104317. doi: <http://doi.org/10.1016/j.jlp.2020.104317>
  152. Payá-Zaforteza, I., Garlock, M. E. M. (2010). A 3D numerical analysis of a typical steel highway overpass bridge under a hydrocarbon fire. *Structures in Fire – Proceedings of the Sixth International Conference, SiF'10*, 11–18.
  153. ZVT-Tunnel – Zusatzliche technische Vertragsbedingungen und Richtlinien für den Bau von Strassentunneln. Tel. 1,2,4. Ausgabe, 1995 und 2000.
  154. Subota, A. V., Semerak, M. M., Stokaliuk, O. V. (2014). Definition and study of the temperature field in the elements of metal structure in hydrogen combustion temperature mode. *Pozhezhna bezpeka*, 24, 120–123.
  155. Yakymenko, O. P. (2012). *Pidvyshchennia vohnestiikosti zalizobetonnykh oprav tunelnykh sporud*. Kyiv, 141.
  156. Enaleev, R. Sh., Telyakov, E. Sh., Tuchkova, O. A., Kachalkin, A. V., Osipova, L. E. (2010). Ognestoikost elementov stroitelnykh konstruksii pri pozharakh v neftegazovom komplekse. *Butlerovskie soobscheniya*, 19 (3), 66–75.
  157. Tuchkova, O. A. (2011). Gradientno-temperaturnyi kriterii ognestoikosti betonnykh konstruksii pri pozharakh v khimicheskoi otrasli promyshlennosti. *Kazan*, 117.
  158. Calabrese, L., Cattani, L., Vocale, P. (2014). Parameter estimation approach applied to the characterization of an intumescent fire retardant paint. *JP Journal of Heat and Mass Transfer*, 9 (2), 101–116.
  159. Zehfuß, J., Sander, L., Schaumann, P., Weisheim, W. (2018). Thermische Materialeigenschaften von Brandschutzmaterialien für Naturbrandbeanspruchungen. *Bautechnik*, 95 (8), 535–546. doi: <http://doi.org/10.1002/bate.201800033>
  160. Weisheim, W., Schaumann, P., Sander, L., Zehfuß, J. (2020). Numerical model for the fire protection performance and the design of intumescent coatings on structural steel exposed to natural fires. *Journal of Structural Fire Engineering*, 11 (1), 33–50. doi: <http://doi.org/10.1108/jsfe-01-2019-0004>
  161. Yasir, M., Ahmad, F., Yusoff, P. S. M. M., Ullah, S., Jimenez, M. (2019). Latest trends for structural steel protection by using intumescent fire protective coatings: a review. *Surface Engineering*, 36 (4), 334–363. doi: <http://doi.org/10.1080/02670844.2019.1636536>
  162. Wang, L., Dong, Y., Zhang, C., Zhang, D. (2015). Experimental Study of Heat Transfer in Intumescent Coatings Exposed to Non-Standard Furnace Curves. *Fire Technology*, 51 (3), 627–643. doi: <http://doi.org/10.1007/s10694-015-0460-7>
-

- 
163. STB 11.03.02-2010. Fire safety standards system. Fire protection. General technical requirements and test methods (2010). Available at: <https://files.stroyinf.ru/Index2/1/4293725/4293725240.htm>
  164. GOST 28574-90 *Zaschita ot korrozii v stroitelstve. Konstruktsii betonnye i zhelezobetonnye. Metody ispytanii adgezii zaschitnykh pokrytii. Vved. 01.01.1991 (2004)*. Moscow: Standartinform, 7.
  165. GOST 15140-78 *Materialy lakokrasochnye. Metody opredeleniya adgezii. Vved. 01.01.1979 (1990)*. Moscow: Gosudarstvennyi komitet SSSR po standartam, 12.
  166. ETAG No. 018-1:2004 *Guide for the European technical approval of fire protective products – Part 1: General (2004)*. Available at: <https://www.itb.pl/g/f/NDYz>
  167. ETAG No. 018-2:2013 *Guide for the European technical approval of fire protective products – Part 2: Reactive coatings for fire protection of steel elements (2013)*. Available at: <https://www.nlfnorm.cz/en/ehn/6383>
  168. ETAG No. 018-3:2013 *Guide for the European technical approval of fire protective products – Part 3: Renderings and rendering kits intended for fire resisting applications*. Available at: <https://www.itb.pl/g/f/NDY1>
  169. ETAG No. 018-4:2011 *Guide for the European technical approval of fire protective products – Part 4: Fire protective board, slab and mat products and kits*. Available at: <https://www.eota.eu/sites/default/files/uploads/ETAGs/etag-018-part4-ec-version-december-2011.pdf>
  170. GOST 9.401–91. *Pokrytiya lakokrasochnye. Obschie trebovaniya i metody uskorennykh ispytanii na stoikost k vozdeistviyu klimaticheskikh faktorov. Data vvedeniya 1992-07-01 (1991)*. Moscow: MKHNP, 55.
  171. Jimenez, M., Bellayer, S., Revel, B., Duquesne, S., Bourbigot, S. (2013). *Comprehensive Study of the Influence of Different Aging Scenarios on the Fire Protective Behavior of an Epoxy Based Intumescent Coating*. *Industrial & Engineering Chemistry Research*, 52 (2), 729–743. doi: <http://doi.org/10.1021/ie302137g>
  172. Zybina, O., Gravit, M., Stein, Y. (2017). *Influence of carbon additives on operational properties of the intumescent coatings for the fire protection of building constructions*. *IOP Conference Series: Earth and Environmental Science*, 90, 012227. doi: <http://doi.org/10.1088/1755-1315/90/1/012227>
  173. Ustinov, A., Zybina, O., Tomakhova, A., Pavlov, S. (2018). *The enhancement of operating properties of intumescent fire-protective compositions*. *MATEC Web of Conferences*, 245, 11008. doi: <http://doi.org/10.1051/mateconf/201824511008>
  174. Zubielewicz, M., Langer, E., Królikowska, A. (2021). *Trends in the development of intumescent paints for the protection of steel structures and new related with them expectations*. *Ochrona Przed Korozja*, 1 (7), 4–12. doi: <http://doi.org/10.15199/40.2021.7.1>
  175. Wang, L. L., Wang, Y. C., Li, G. Q. (2013). *Experimental study of hydrothermal aging effects on insulative properties of intumescent coating for steel elements*. *Fire Safety Journal*, 55, 168–181. doi: <http://doi.org/10.1016/j.firesaf.2012.10.004>
-

- 
176. Wang, L. L., Wang, Y. C., Yuan, J. F., Li, G. Q. (2012). Thermal conductivity of intumescent coating char after accelerated aging. *Fire and Materials*, 37 (6), 440–456. doi: <http://doi.org/10.1002/fam.2137>
  177. Wang, J. (2016). The protective effects and aging process of the topcoat of intumescent fire-retardant coatings applied to steel structures. *Journal of Coatings Technology and Research*, 13 (1), 143–157. doi: <http://doi.org/10.1007/s11998-015-9733-9>
  178. Roberts, T. A., Shirvill, L. C., Waterton, K., Buckland, I. (2010). Fire resistance of passive fire protection coatings after long-term weathering. *Process Safety and Environmental Protection*, 88 (1), 1–19. doi: <http://doi.org/10.1016/j.psep.2009.09.003>
  179. Dong, Y., Wang, G., Su, Q. (2014). Influence of degree of polymerization of ammonium polyphosphate on anti-aging property of waterborne fire resistive coatings. *Surface and Coatings Technology*, 246, 71–76. doi: <http://doi.org/10.1016/j.surfcoat.2014.03.009>
  180. Çirpıcı, B. K., Orhan, S. N., Kotan, T. (2019). Numerical modelling of heat transfer through protected composite structural members. *Challenge Journal of Structural Mechanics*, 5 (3), 96. doi: <http://doi.org/10.20528/cjsmec.2019.03.003>
  181. Elliott, A., Temple, A., Maluk, C., Bisby, L. (2014). Novel Testing to Study the Performance of Intumescent Coatings under Non-Standard Heating Regimes. *Fire Safety Science*, 11, 652–665. doi: <http://doi.org/10.3801/iafss.fss.11-652>
  182. Lucherini, A., Maluk, C. (2017). Novel test methods for studying the fire performance of thin intumescent coatings. *Proceedings of 2nd International Fire Safety Symposium (IFireSS)*. Napoli, 565–572.
  183. Li, G., Han, J., Wang, Y. C. (2017). Constant effective thermal conductivity of intumescent coatings: Analysis of experimental results. *Journal of Fire Sciences*, 35 (2), 132–155. doi: <http://doi.org/10.1177/0734904117693857>
  184. Kolšek, J., Češarek, P. (2015). Performance-based fire modelling of intumescent painted steel structures and comparison to EC3. *Journal of Constructional Steel Research*, 104, 91–103. doi: <http://doi.org/10.1016/j.jcsr.2014.10.008>
  185. Bozzoli, F., Mocerino, A., Rainieri, S., Vocale, P. (2018). Inverse heat transfer modeling applied to the estimation of the apparent thermal conductivity of an intumescent fire retardant paint. *Experimental Thermal and Fluid Science*, 90, 143–152. doi: <http://doi.org/10.1016/j.exthermflusci.2017.09.006>
  186. Kraus, P., Mensinger, M., Tabeling, F., Schaumann, P. (2015). Experimental and Numerical Investigations of Steel Profiles with Intumescent Coating Adjacent to Space-Enclosing Elements in Fire. *Journal of Structural Fire Engineering*, 6 (4), 237–246. doi: <http://doi.org/10.1260/2040-2317.6.4.237>
  187. Standard for Safety for Rapid Rise Fire Tests of Protection Materials for Structural Steel: ANSI/UL 1709 (2007). Available at: <https://ua1lib.org/book/14973256/24a856>
  188. Standard Methods of Fire Endurance Tests of Building Construction and Materials: CAN/ULC-S101-04. Available at: <https://www.scc.ca/en/standardsdb/standards/19257>
-

- 
189. Gong, J., Xiang, Q., Zhao, M. (2014). Laboratory Research on Composite Tunnel Fire-Retardant Coating. *Materials and Manufacturing Processes*, 30 (6), 699–705. doi: <http://doi.org/10.1080/10426914.2014.941872>
  190. Zhang, Y., Wang, Y. C., Bailey, C. G., Taylor, A. P. (2012). Global modelling of fire protection performance of an intumescent coating under different furnace fire conditions. *Journal of Fire Sciences*, 31 (1), 51–72. doi: <http://doi.org/10.1177/0734904112453566>
  191. Andronov, V., Pospelov, B., Rybka, E. (2016). Increase of accuracy of definition of temperature by sensors of fire alarms in real conditions of fire on objects. *Eastern-European Journal of Enterprise Technologies*, 4 (5 (82)), 38–44. doi: <http://doi.org/10.15587/1729-4061.2016.75063>
  192. Maliarenko, V. A., Redko, A. F., Chaika, Yu. Y., Povolochko, V. B. (2001). *Tekhnichna teplofizyka ohorodzhuiuchykh konstruksii budivel ta sporud*. Kharkiv: Rubikon, 280.
  193. Kovalov, A. I. (2017). Justification of parameters of fire protective plaster of coating for protecting concrete structures. *Naukovyi visnyk: tsyvilnyi zakhyst ta pozhezhna bezpeka*, 1 (3), 20–27.
  194. Krukovskii, P. G., Kovalev, A. I., CHernenko, K. A., Metel, M. A., Abramov, A. A. (2012). Modelling of thermal state and fire-resistance quality of hollow core armoured concrete floors. *Pozharnaya bezopasnost*, 21, 85–94.
  195. Kovalov, A., Otrosh, Y., Ostroverkh, O., Hrushovinchuk, O., Savchenko, O. (2018). Fire resistance evaluation of reinforced concrete floors with fire-retardant coating by calculation and experimental method. *E3S Web of Conferences*, 60, 00003. doi: <http://doi.org/10.1051/e3sconf/20186000003>
  196. Kovalov, A., Konoval, V., Khmyrova, A., Dudko, K. (2019). Parameters for simulation of the thermal state and fire-resistant quality of hollow-core floors used in the mining industry. *E3S Web of Conferences*, 123, 01022. doi: <http://doi.org/10.1051/e3sconf/201912301022>
  197. Kovalev, A. I. (2013). Opređenje karakteristiki ognegaschitnoi sposobnosti pokrytii zhelezobetonnykh perekrytii dlya razlichnykh temperaturnykh rezhimov pozhara. *Pozhezhna bezpeka: teoriya i praktika*, 13, 4–9.
  198. Kovalev, A. I. (2013). Vliyanie parametrov modeli na tochnost opredeleniya teplofizicheskikh kharakteristik ognegaschitnogo pokrytiya. *Pozhezhna bezpeka: teoriya i praktika*, 14, 64–68.
  199. Kovalev, A. I., Krukovskii, P. G., Kachkar, E. V. (2012). Opređenje kharakteristik vspuchivayuschegosya ognegaschitnogo pokrytiya «Feniks STV» po dannym ispytaniu na ognestoikost monolitnogo perekrytiya. *Pozhezhna bezpeka: teoriya i praktika*, 11, 43–51.
  200. Kovalev, A. Y. (2012). Evaluation of fire resistance rating of multi-hollow ferroconcrete floors with fire-retardant coatings by experiment-calculation method. *Naukovyi visnyk UkrNDIPB*, 2, 28–34.
  201. Kovalov, A. I., Otrosh, Yu. A., Danilin, O. M. (2019). Experimental studies of fire resistance of reinforced concrete floors with fire protection system. *Problemy pozharnoi bezopasnosti*, 45, 73–78.
  202. Alifanov, O. M. (1988). *Obratnye zadachi teploobmena*. Moscow: Mashinostroenie, 280.
-

- 
203. Alifanov, O. M., Artyukhin, E. A. (1988). Ekstremalnye metody resheniya nekorrektnykh zadach i ikh prilozheniya k obratnym zadacham teploobmena. Moscow: Nauka, 285.
  204. Artyukhin, E. A. (1975). Opredelenie koeffitsienta temperaturoprovodnosti po dannym eksperimenta. Inzhenerno-fizicheskii zhurnal, 29 (1), 87–90.
  205. Krukovskii, P. G. (1998). Obratnye zadachi teplomassoperenosa (obschii inzhenernyi podkhod). Kyiv: Institut tekhnicheskoi teplofiziki NAN Ukrainy, 218.
  206. Alifanov, O. M., Vabishechich, P. N., Mikhailov, V. V., Nenarokomov, A. V., Polezhaev, Yu. V., Reznik, S. V. (2001). Osnovy identifikatsii i proektirovaniya teplovykh protsessov i sistem. Moscow: Logos, 400.
  207. Kozdoba, L. A., Krukovskii P. G. (1982). Metody resheniya obratnykh zadach teploperenosa. Kyiv: Nauka i tekhnicheskii progress, 360.
  208. Faddeev, D. K., Faddeeva, V. N. (1963). Vychislitelnye metody lineinoi algebry. Vol. 960. Fizmatgiz.
  209. Krukovskii, P. G. (1994). Universalnyi programmno-metodicheskii podkhod k resheniyu obratnykh zadach teplomassoperenosa (programma FRIEND). Identifikatsiya dinamicheskikh sistem i obratnye zadachi. Saint Petersburg, 1.
  210. Kozdoba, L. A. (1992). Vychislitelnaya teplofizika. Kyiv: Naukova dumka, 224.
  211. Bek, Dzh., Blekuell, B. (1989). Nekorrektnye obratnye zadachi teploprovodnosti. Moscow: Mir, 312.
  212. Berkovskii, B. M., Nogotov, E. F. (1976). Raznostnye metody issledovaniya zadach teploobmena. Minsk: Nauka i tekhnika, 141.
  213. Krukovskii, P. G. (2003). Raschetno-eksperimentalnyi podkhod k analizu protsessov teplomassoobmena (metodologiya i primery primeneniya). Promyshlennaya teplotekhnika, 25 (4), 396–398.
  214. DSTU, B. (2007). 1.1-14: 2007 (EN 1365-4: 1999, NEG). Kolony. Metod vyprovuvannya na vohnestiikist (2007). Nakaz Ministerstva rehionalnoho rozvytku ta budivnytstva Ukrainy No. 63. 22.06.2007. Kyiv: Minrehionbud Ukrainy.
  215. DSTU B V.1.1-4-98\*. Zakhyst vid pozhezhi. Budivelni konstruksii. Metody vyprovuvannya na vohnestiikist. Zahalni vymohy. Chynnyi vid 1998-10-28. (2005). Vyd. Derzhbud Ukrainy, 18.
  216. Kovalov, A. I., Otrosh, Yu. A., Kosse, A. G., Chernenko, O. M. (2020). Dependence of the accuracy of determining the thermophysical characteristics of fire retardant coatings on the parameters of the model. Problemy pozharnoi bezopasnosti, 48, 63–70.
  217. Kovalov, A., Otrosh, Y., Surianinov, M., Kovalevska, T. (2019). Experimental and Computer Researches of Ferroconcrete Floor Slabs at High-Temperature Influences. Materials Science Forum, 968, 361–367. doi: <http://doi.org/10.4028/www.scientific.net/msf.968.361>
  218. Kovalev, A. I. (2012). Vliyanie pogreshnostei v izmerenii temperatur na tochnost opredeleniya teplofizicheskikh kharakteristik pokrytii monolitnykh zhelezobetonnykh perekritii. Pozhezhna bezpeka: teoriya i praktika, 12, 41–45.
  219. Kovalov, A. I., Otrosh, Y. A., Kovalevska, T. M., Safronov, S. O. (2019). Methodology for assessment of the fire-resistant quality of reinforced-concrete floors protected by fire-retar-
-



- dant coatings. IOP Conference Series: Materials Science and Engineering, 708 (1), 012058. doi: <http://doi.org/10.1088/1757-899x/708/1/012058>
220. Kovalov, A. I. (2017). The Influence of Random Errors in the Measurement of Temperatures on the Inaccuracy of Determination of Thermophysical Characteristics of Coatings of Reinforced Concrete Floors. *Problemi pozharnoi bezopasnosti*, 41, 87–91.
221. Kovalev, A. I., Krukovskii, P. G., Abramov, A. A. (2012). Analiz vliyaniya oshibok izmereniya temperatur na pogreshnost opredeleniya teplofizicheskikh i ognegaschitnykh kharakteristik pokrytii zhelezobetonnykh perekritii. *Pozhezhna bezpeka: teoriya i praktika*, 10, 66–72.
222. Kovalov, A. I., Kachkar, Ye. V., Zobenko, N. V., Tyshchenko, O. M. (2014). Osoblyvosti zastosuvannya pokryttiv metalevykh konstruksii pry riznykh temperaturnykh rezhymakh pozhezhi. *Pozhezhna bezpeka: teoriya i praktyka*, 16, 135–139.
223. Kovalov, A. I., Otrosh, Yu. A., Tomenko, V. I., Danilin, O. M., Bezuhla, Yu. S., Karpets, K. M. (2020). Estimation of the fire-protective capacity of reactive coatings of steel structures. *Problemy nadzvychainykh sytuatsii*, 2 (32), 44–55.
224. Kovalev, A. I., Dashkovskii, V. Iu. (2014). Research of the Fireproof Capability of “Amotherm Steel Wb” Coating for Metal Constructions Protection Using an Experiment-Calculation Method. *Bezpieczeństwo i Technika Pożarnicza*, 35, 107–113. doi: <http://doi.org/10.12845/bitp.35.3.2014.9>
225. Kovalev, A. I., Zobenko, N. V. (2016). Testing the Accuracy of Designating the Parameters of Intumescent Coatings of Metal Constructions. *Bezpieczeństwo i Technika Pożarnicza*, 43, 45–50. doi: <http://doi.org/10.12845/bitp.43.3.2016.4>
226. Kovalov, A. I., Zobenko, N. V. (2016). Preliminary assessment technique of coating flame retardant capacity for steel structures under hydrocarbon firetemperature conditions. *Naukovyi visnyk: tsyvilnyi zakhyst ta pozhezhna bezpeka*, 1, 59–65.
227. Kovalov, A., Slovynskiy, V., Udianskyi, M., Ponomarenko, I., Anszczak, M. (2020). Research of Fireproof Capability of Coating for Metal Constructions Using Calculation-Experimental Method. *Materials Science Forum*, 1006, 3–10. doi: <http://doi.org/10.4028/www.scientific.net/msf.1006.3>
228. Kovalov, A. I., Zobenko, N. V., Otrosh, Yu. A., Khmyrov, I. M., Danilin, O. M. (2018). Accuracy of determination of parameters of coatings of steel structures under conditions of the temperature regime of a hydrocarbon fire. *Problemi pozharnoi bezopasnosti*, 43, 73–79.
229. Kovalov, A. I., Vedula, S. A., Hrushovinchuk, O. V. (2017). Peculiarities and problems of determination of the predicted durability term of steel constructions coatings. *Visnyk Pryazovskoho derzhavnogo tekhnichnoho universytetu. Seriya: Tekhnichni nauky*, 34, 232–238.
230. Nuianzin, V. M., Kovalov, A. I., Vedula, S. A. (2016). Experimental researches of influence of climatic factors on flame retardant ability of coatings for steel structures. *Visnyk KrNU imeni Mykhaila Ostrohradskoho*, 5, 70–75.

231. Kovalov, A. I., Otrosh, Yu. A., Danilin, O. M., Aleksieieva, O. S., Khmyrov, I. M. (2018). Method of assessment of fire fighting safety coatings of steel constructions under the influence of climatic factors. *Problemi pozharnoi bezopasnosti*, 44, 49–56.
232. Kovalov, A. I., Otrosh, Y. A., Vedula, S., Danilin, O. M., Kovalevska, T. M. (2019). Parameters of fire-retardant coatings of steel constructions under the influence of climatic factors. *Naukovi Visnyk Natsionalnoho Hirnychoho Universytetu*, 3, 46–53. doi: <http://doi.org/10.29202/nvngu/2019-3/9>
233. DSTU-N B EN 1993-1-2:2010 “Yevrokod 3. Proektuvannia stalevykh konstruksii. Chastyna 1-2. Zahalni polozhennia. Rozrakhunok konstruksii na vohnestikiist (EN 1993-1-2:2005, IDT)” (2010). Available at: [http://online.budstandart.com/ua/catalog/doc-page?id\\_doc=26637](http://online.budstandart.com/ua/catalog/doc-page?id_doc=26637)
234. DBN V.1.1-7:2016 Pozhezhna bezpeka ob`yektiv budivnytstva. Zahalni vymohy. Chynnyi vid 2017-06-01 (2017). Vyd. Ukrainyskyi naukovo-doslidnyi instytut tsyvilnoho zakhystu UKRNDITsZ, 35.
235. Kovalov, A., Otrosh, Y., Chernenko, O., Zhuravskij, M., Anszczak, M. (2021). Modeling of Non-Stationary Heating of Steel Plates with Fire-Protective Coatings in Ansys under the Conditions of Hydrocarbon Fire Temperature Mode. *Materials Science Forum*, 1038, 514–523. doi: <http://doi.org/10.4028/www.scientific.net/msf.1038.514>
236. Tsoi, A. A., Demekhin, F. V. (2015). Testing of fire resistant materials in the conditions of the hydrocarbon temperature mode. *Nauchno-analiticheskii zhurnal Vestnik Sankt-Peterburgskogo universiteta Gosudarstvennoi protivopozharnoi sluzhby MCHS Rossii*, 4, 20–24.
237. Kovalov, A. I., Kachkar, Ye. V., Zobenko, N. V., Dolishnii, Yu. V. (2014). Eksperymentalne doslidzhennia vohnezakhysnoi zdatnosti pokryttia Amotherm Steel Wb pry temperaturnomu rezhymovi vuhlevodorodnoyi pozhehzi. *Pozhezhna bezpeka: teoriia i praktyka*, 17, 53–60.
238. Kovalov, A. I., Slovynskyi, V. K. (2019). Research of fireproof capability of coating for metal constructions using experiment and calculation method. *Nadzvychnaii sytuatsii: poperedzhennia ta likvidatsiia*, 3 (2), 37–47.
239. Kovalev, A. I., Zobenko, N. V., Oliinik, I. Ya. (2017). Opredelenie kharakteristik ognezashchitnoy sposobnosti pokrytii metallicheskih konstruksii pri ikh ispitaniyakh v usloviyakh temperaturnogo rezhima uglevodorodnogo pozhara. *New technologies and achievements in metallurgy, material engineering, production engineering and physics*.
240. Kovalov, A. I., Otrosh, Yu. A., Tomenko, V. I. (2020). The modelling of the thermal state of the steel constructions under the hydrocarbon fire temperature mode. *Problemy nadzvychnykh sytuatsii*, 31, 187–197.
241. Kovalov, A. I. (2017). Doslidzhennia tochnosti vyznachennia parametriv pokryttiv dlia vohnezakhystu stalevykh konstruksii. *Promyslove budivnytstvo ta inzhenerni sporudy*, 4, 11–15.
242. Vasilchenko, A., Otrosh, Y., Adamenko, N., Doronin, E., Kovalov, A. (2018). Feature of fire resistance calculation of steel structures with intumescent coating. *MATEC Web of Conferences*, 230, 02036. doi: <http://doi.org/10.1051/mateconf/201823002036>

## REFERENCES

---

243. Pospelov, B., Rybka, E., Meleshchenko, R., Krainiukov, O., Biryukov, I., Butenko, T. et. al. (2021). Short-term fire forecast based on air state gain recurrence and zero-order brown model. *Eastern-European Journal of Enterprise Technologies*, 3 (10 (111)), 27–33. doi: <http://doi.org/10.15587/1729-4061.2021.233606>
244. Guzii, S. G., Otrosh, Y., Guzii, O., Kovalov, A., Sotiriadis, K. (2021). Determination of the Fire-Retardant Efficiency of Magnesite Thermal Insulating Materials to Protect Metal Structures from Fire. *Materials Science Forum*, 1038, 524–530. doi: <http://doi.org/10.4028/www.scientific.net/msf.1038.524>
245. Kovalev, A. I. (2012). Vliyanie pogreshnosti v izmerenii temperatur na tochnost opredeleniya teplofizicheskikh kharakteristik pokrytii monolitnykh zhelezobetonnykh perekrytii. *Pozhezhna bezpeka: teoriya i praktika*, 12, 41–45.
246. Kovalev, A. I. (2007). K probleme otsenki adgezii ognegaschitnykh pokrytii *Naukovii visnik budivnitstva*, 41, 273–275.

Edited by  
Volodymyr Sadkovyi, Evgeniy Rybka, Yurii Otrosh

FIRE RESISTANCE OF REINFORCED CONCRETE AND STEEL STRUCTURES

Volodymyr Sadkovyi, Volodymyr Andronov, Oleg Semkiv, Andrii Kovalov, Evgeniy Rybka,  
Yurii Otrosh, Mykola Udianskyi, Volodymyr Koloskov, Alexander Danilin, Pavlo Kovalov

Monograph

Technical editor I. Prudius  
Desktop publishing T. Serhiienko  
Cover photo Copyright © 2021 Canva

---

PC TECHNOLOGY CENTER  
Published in December 2021  
Enlisting the subject of publishing No. 4452 – 10.12.2012  
Address: Shatylova dacha str., 4, Kharkiv, Ukraine, 61165

---